

TLG-LØV

Circular diffuser

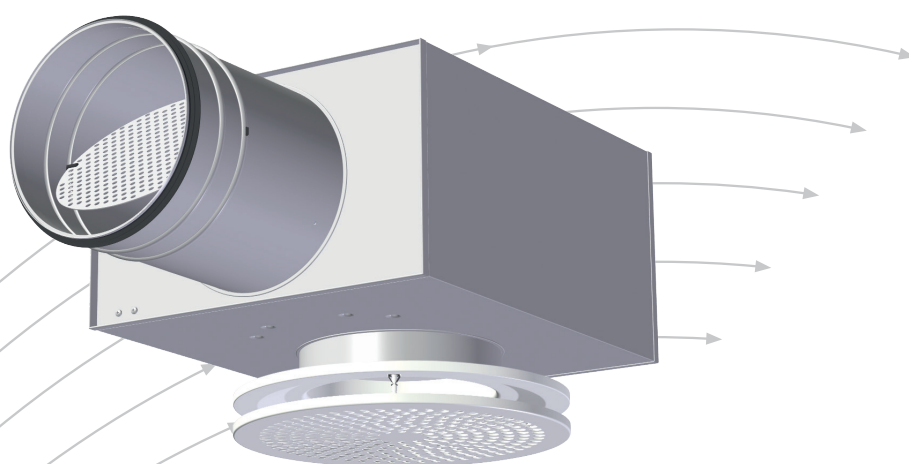

- Design-protected LØV perforation
- Excellent low temperature resistance
- Adjustable slot height
- Low-profile design
- Data provided with Luna plenum box installed
- Box lined with sound absorber in polyester

TROX[®] TECHNIK

 **Auranor**

TROX Auranor Norge AS

PO Box 100
NO-2712 Brandbu

Telefon +47 61 31 35 00
Telefaks+47 61 31 35 10
e-mail: firmapost@auranor.no
www.trox.no

TLG-LØV



APPLICATION

TLG-LØV is a circular supply diffuser for ceiling mounting. TLG-LØV offers excellent induction, and is suitable for both constant and variable air flow rates.

DESIGN

TLG-LØV features a front panel with LØV perforation and adjustable slot height.

MATERIALS AND SURFACE COATING

The diffuser and ceiling plate are in a steel design, and the connection collar is equipped with an EPDM rubber gasket. All internal and external diffuser elements come in a RAL 9003 - gloss 30 finish. Other colours are available on request.

QUICK SELECTION

TLG-LØV	[m ³ /h]		
Dim.	25 dB(A)	30 dB(A)	35 dB(A)
100	87	104	123
125	144	167	194
160	238	273	312
200	328	378	436
250	609	707	820
315	897	1046	1220

Table 1: The table shows air flow rates at given sound power levels. Maximum slot height and valve fitted directly in straight duct.

ORDER CODE, TLG-LØV (TLG-LOEV)

Product: TLG-LØV-0-125-0 SL = Special finish
 S = Vertical throw pattern
 E = One-way throw pattern
 Dimension: Ø100 – Ø315

Example:
 TLG-LOEV-0-125-0
 Explanation:
 TLG-LOEV dim. Ø125

ORDER CODE, Luna

Product: Luna-0-0-125-125
 UI = Outlet installed, low profile design, Dimension outlet: Ø100 – Ø315
 I = Insulated, Dimension inlet: Ø100 – Ø315

Example:
 Luna-0-0-125-125
 Explanation:
 Luna plenum box with inlet Ø125 and outlet Ø125.

DIMENSIONS AND WEIGHT, LØV-R

Dim.	A	B	J	T	Groove dim.	Weight diffuser [kg]
100	209	99	25	34-45	105	0,7
125	238	124	33	34-45	130	0,9
160	279	159	35	36-50	165	1,1
200	334	199	35	38-52	205	1,4
250	419	249	83	52-72	375	2,1
315	525	314	93	53-73	470	3,0

Table 2

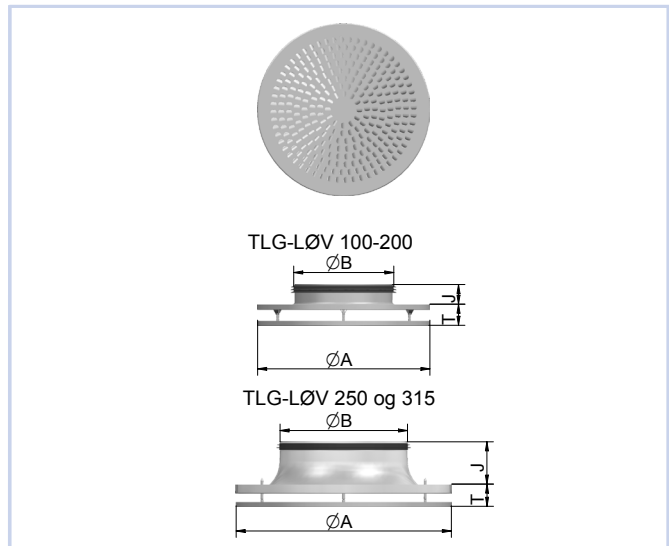

Fig.1

TLG-LØV with Luna plenum box



APPLICATION

The Luna plenum box is recommended for improved sound attenuation, and works as an adjustment and measurement unit. Luna is a rectangular box equipped with a removable damper which provides access to the connecting duct. The damper can be secured in any position required.

DESIGN

Luna plenum box features a damper and measuring outlet for commissioning. It is insulated with sound absorber in polyester and is available with one or two dimensional changes between inlet and outlet. Furthermore, the box can be delivered with external condensation insulation [I].

A lowprofile design [UI] is also available, and **for this design a reduction in capacity of approx. 20% will apply.** The distance between diffuser and box can be increased by up to 35 cm without extending the wire and measuring tube.

MATERIALS AND SURFACE COATING

Luna is supplied a galvanised finish, and with all four internal walls lined with sound absorber in polyester. The connection collar is fitted with an EPDM rubber gasket.

QUICK SELECTION

TLG-LØV Dim.	Luna Dim.	[m ³ /h]		
		25 dB(A)	30 dB(A)	35 dB(A)
100	100-100	67	81	97
125	100-125	77	103	133
	125-125	94	112	133
160	125-160	94	130	169
	160-160	148	176	216
200	160-200	162	198	245
	200-200	216	252	295
250	200-250	245	295	389
	250-250	349	403	493
315	250-315	331	421	533
	315-315	547	626	720

Table 3: The table provides air flow rates at given sound power levels and 50 Pa total pressure loss.

ORDER CODE, TLG-LØV (TLG-LOEV) with Luna

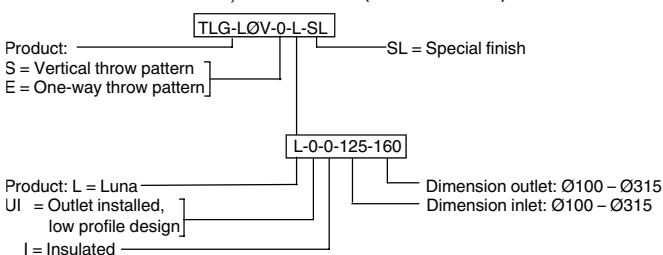

Example:
TLG-LOEV-0-L-0-0-125-160-SL
Explanation:
TLG-LOEV diffuser and Luna plenum box inlet Ø125 and outlet/diffuser dim. Ø160, special finish RAL 9006.
*Colourcode must be remarked.

DIMENSIONS AND WEIGHT, Luna

Dim.	D	DA	B	H	H1	H2	L	L1	L2	Wight Luna [kg]
100-100	99	102	220	122	180	58	325	295	133	2,3
100-125	99	127	220	122	180	58	325	295	133	2,3
100-160	99	162	220	122	180	58	360	310	150	2,4
125-125	124	127	250	147	205	58	360	335	150	2,4
125-160	124	162	250	147	205	58	360	335	150	2,9
125-200	124	202	250	147	205	58	400	355	170	3,1
160-160	159	162	340	182	240	58	400	390	170	4,1
160-200	159	202	340	182	240	58	400	390	170	4,2
160-250	159	252	340	182	285	103	452	415	198	4,6
200-200	199	202	380	222	280	58	452	460	198	5,7
200-250	199	252	380	222	325	103	452	460	198	5,7
200-315	199	317	380	222	325	103	515	485	228	6,1
250-250	249	252	390	272	375	103	515	535	228	7,4
250-315	249	317	390	272	375	103	515	535	228	7,4
315-315	314	317	500	337	440	103	600	655	260	11

Table 4

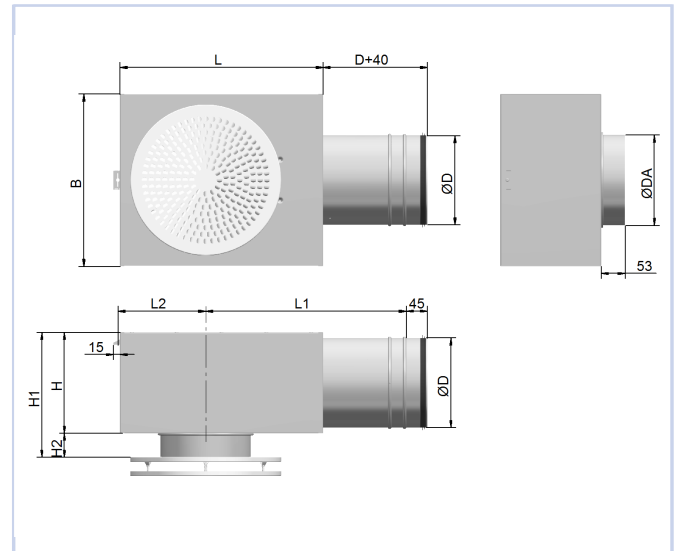

Fig. 2

TLG-LØV

ACOUSTIC DATA

The diagrams provide a summary of the A-weighted sound power level from diffuser, L_{WA} . Correction factors in table 6, page 8, are used to calculate emitted sound power level at the respective frequencies, $L_W = L_{WA} + KO$. A room with absorption equivalent to 10m² Sabine will have a sound pressure level which is 4 dB below the sound power level emitted.

The diagrams assume maximum slot height.

Example:

TLG-LØV with Luna 125-125. Desired air flow rate: 35 l/s. From diagram 4 we find that $L_{WA} = 31$ dB(A) with damper open and 20 Pa total pressure loss. We would like to find the following data:

- Emitted sound power level at 250 Hz
 - A-weighted sound pressure level in an office
 - A-weighted sound pressure level in an office at 50 Pa total pressure loss (i.e. 30 Pa choking with the unit's damper)
- The correction factor is 2 dB. Emitted sound power level at 250 Hz is thus: $L_W = L_{WA} + KO = 31 + (2) = 33$ dB
 - If we assume a room absorption equivalent to 10m² Sabine, A-weighted sound pressure level will be: $31 - 4 = 27$ dB(A)
 - Tracing the 35 l/s line in the diagram up to 50 Pa gives us a reading of 33 dB(A) = increase of 2 dB, and A-weighted sound pressure level will thus be 29 dB(A)

CALCULATION DIAGRAMS

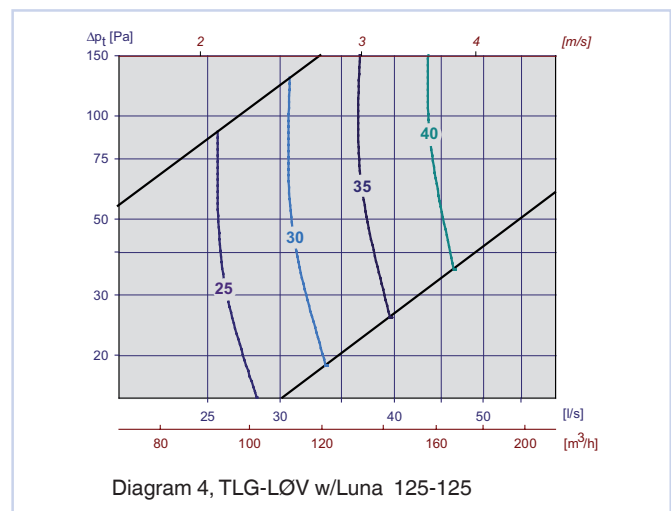
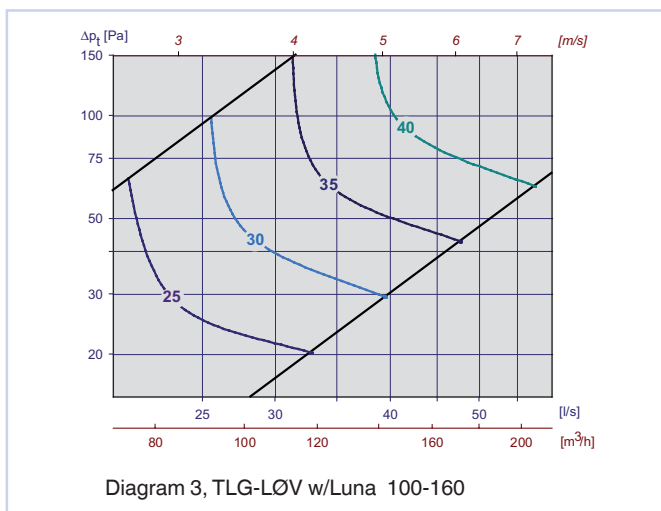
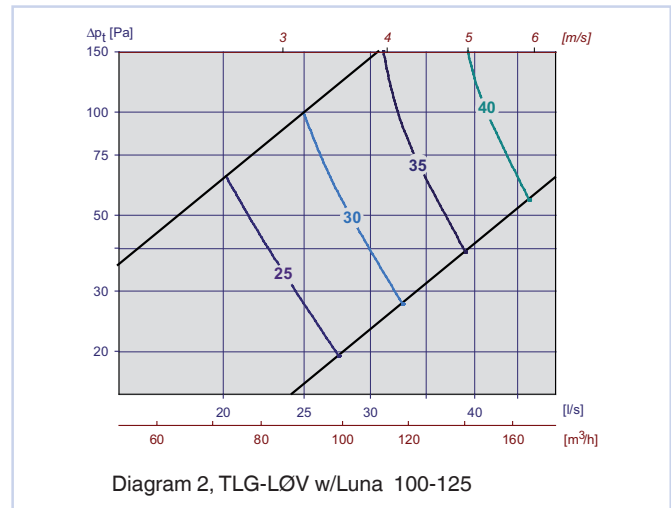
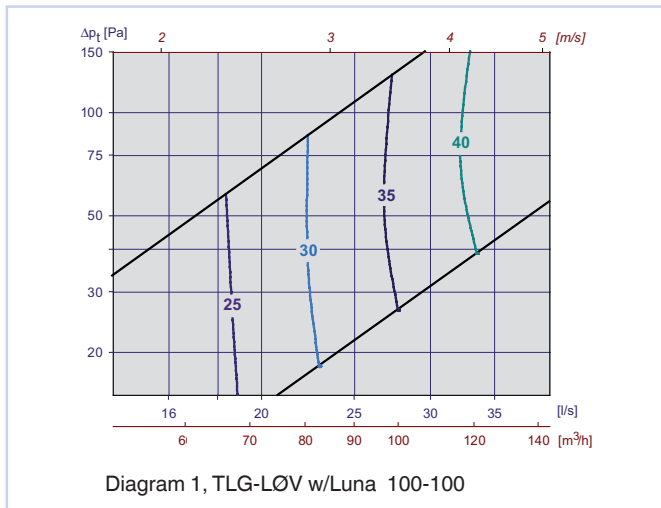

TLG-LØV

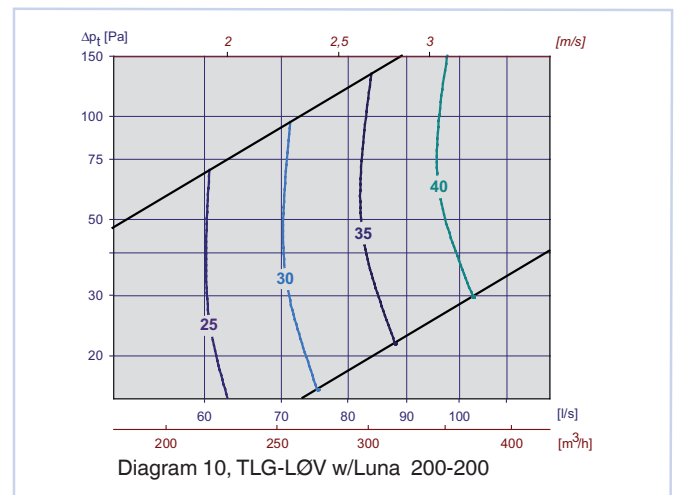
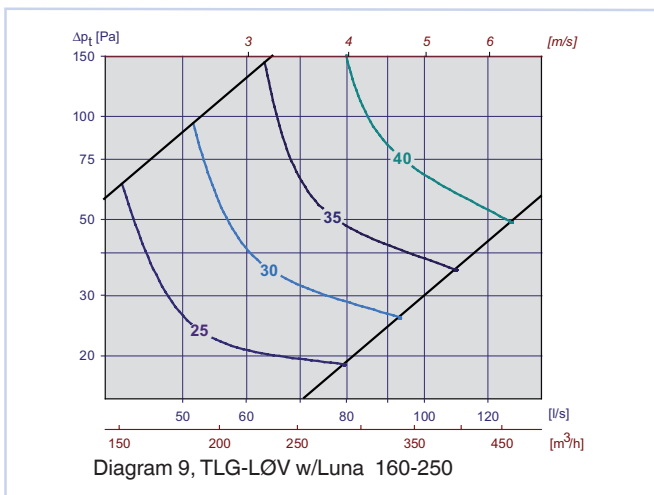
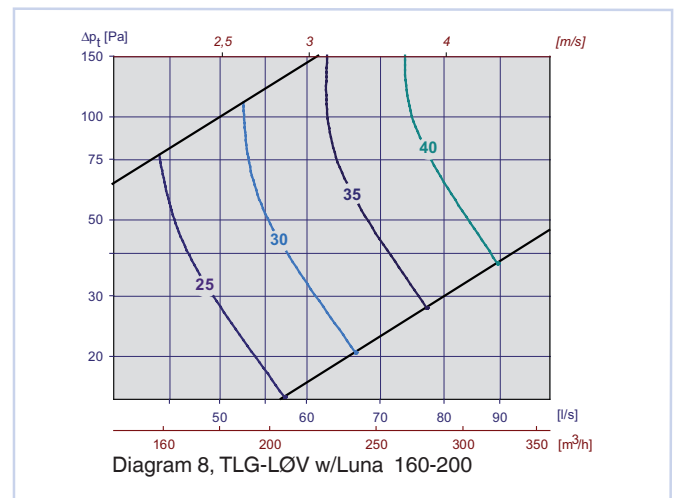
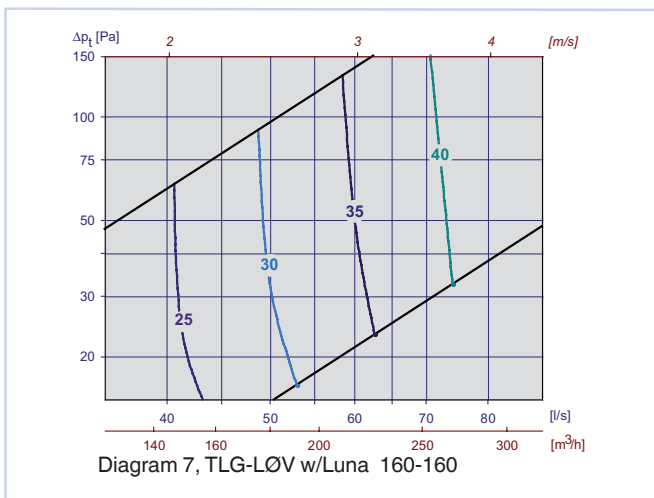
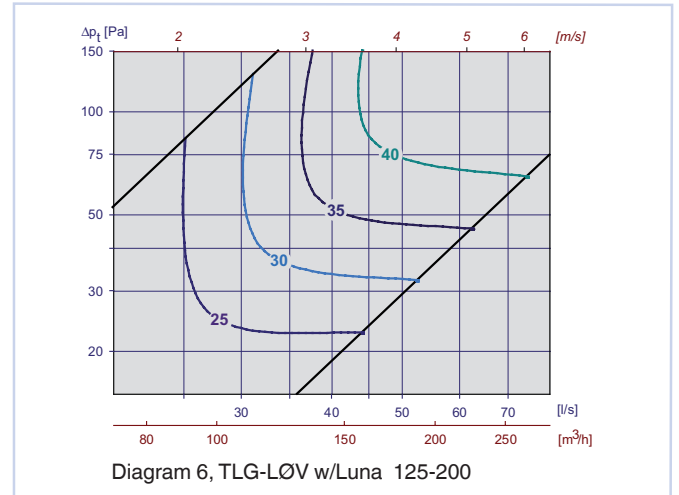
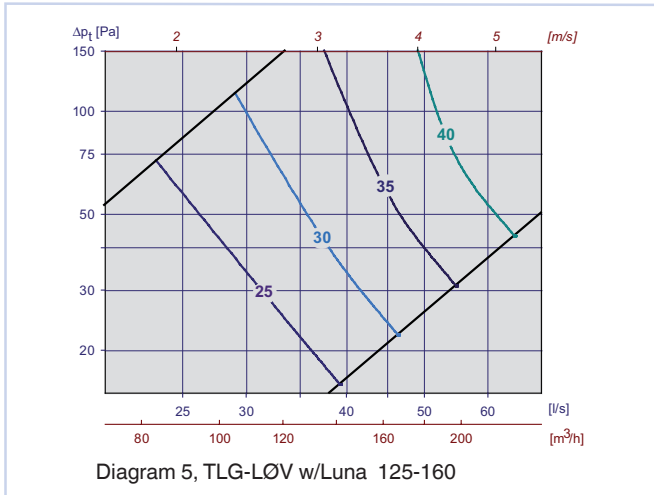

TLG-LØV

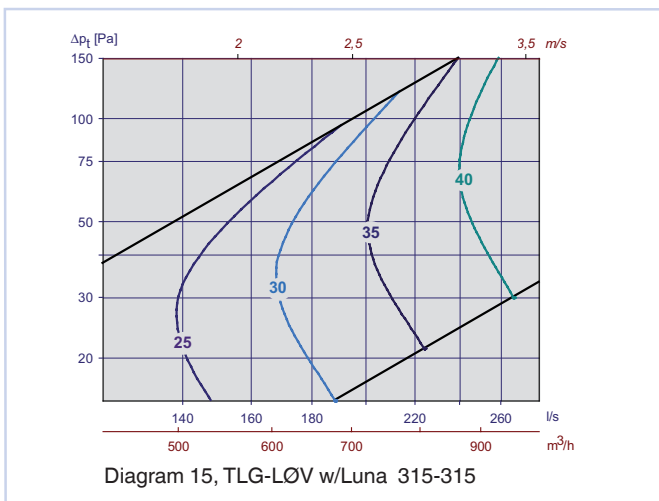
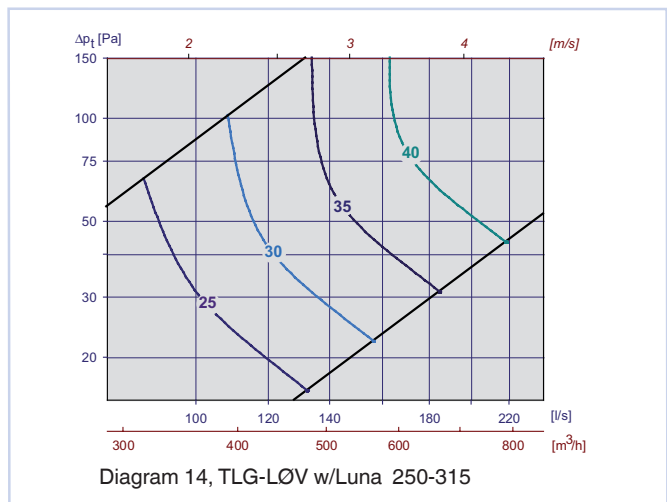
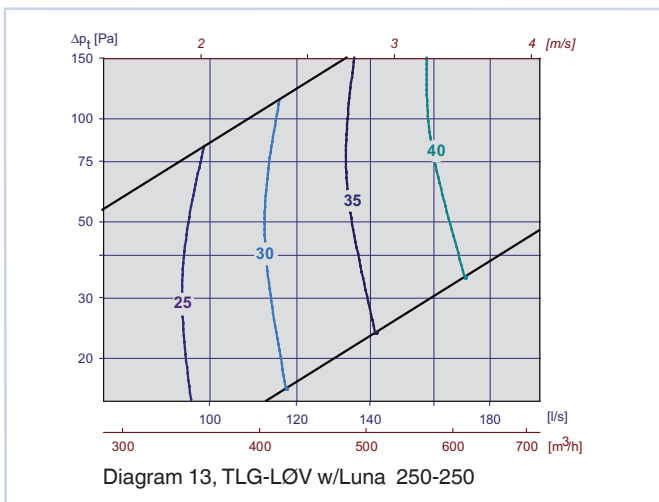
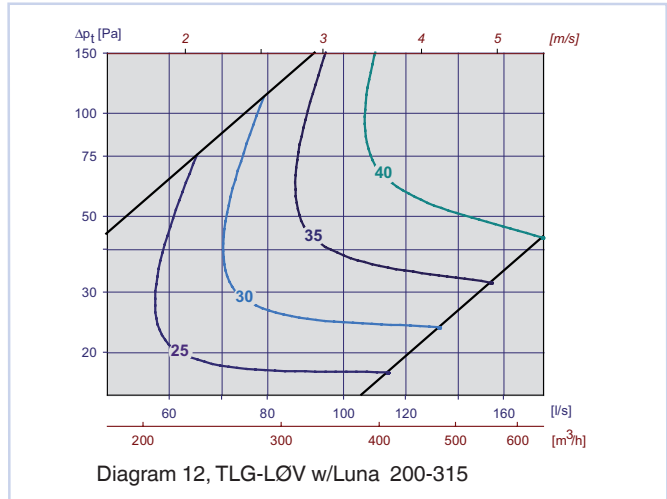
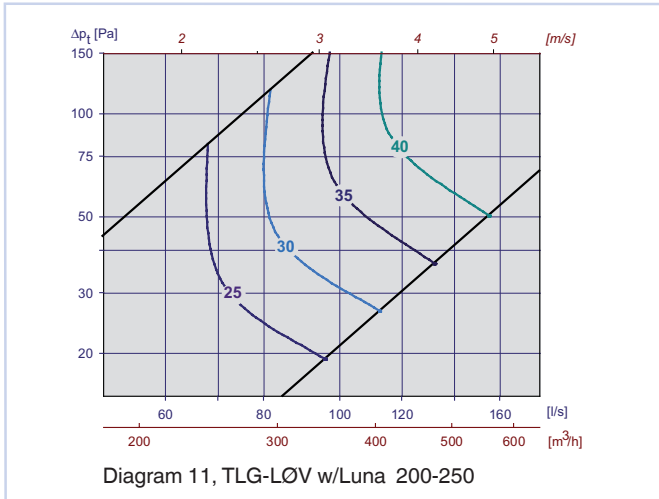

TLG-LØV

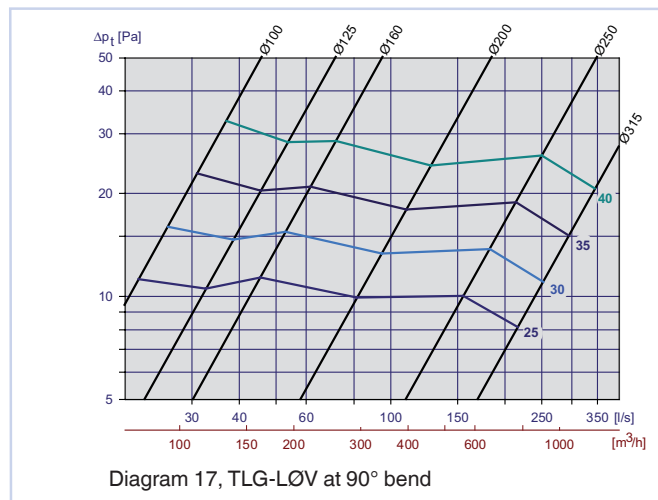
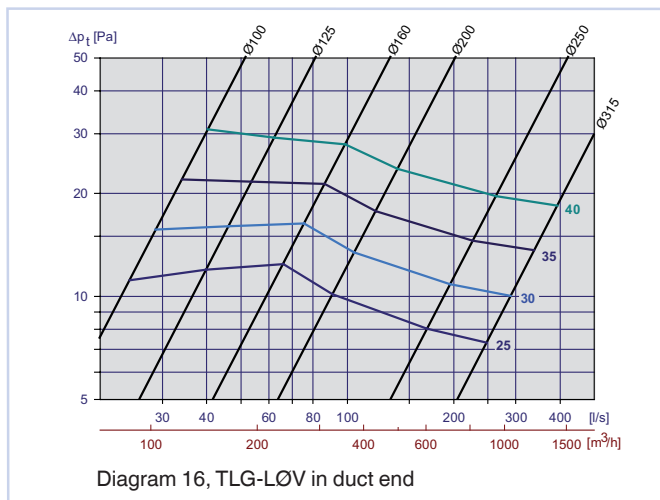

Static sound attenuation incl. end reflection for TLG-LØV with Luna

TLG-LØV Dim.	Luna Dim.	Attenuation [dB]							
		63	125	250	500	1k	2k	4k	8k
100	100-100	25	16	17	20	22	20	16	12
125	100-125	26	12	14	18	20	19	14	17
160	100-160	25	11	13	16	18	19	14	17
125	125-125	24	16	16	20	22	17	13	19
160	125-160	24	11	10	16	19	15	11	17
200	125-200	25	11	9	15	18	15	10	15
160	160-160	20	13	15	16	12	10	11	10
200	160-200	17	9	10	16	18	11	13	17
250	160-250	19	11	12	15	17	10	11	11
200	200-200	18	12	15	18	18	12	16	18
250	200-250	17	12	14	16	16	10	14	16
315	200-315	18	11	13	13	15	9	12	15
250	250-250	15	10	14	15	15	11	13	16
315	250-315	17	11	13	15	14	10	12	14
	315-315	12	9	14	16	11	11	12	14

Table 5

TLG-LØV

Correction factor [KO], TLG-LØV with Luna

TLG-LØV	Luna	KO [dB]															
		Damper closed								Damper open							
Dim.	Dim.	63	125	250	500	1k	2k	4k	8k	63	125	250	500	1k	2k	4k	8k
100	100-100	-4	4	0	-5	-5	-7	-13	-20	-4	1	-2	-6	-5	-6	-14	-24
125	100-125	-2	6	2	-5	-7	-8	-10	-15	-1	6	1	-5	-5	-8	-17	-23
160	100-160	-1	3	4	-5	-8	-9	-10	-13	-2	3	3	-4	-6	-7	-18	-22
125	125-125	1	3	1	-5	-6	-9	-9	-11	2	4	2	-5	-5	-8	-17	-22
160	125-160	-9	0	0	-7	-8	-8	-7	-10	-6	1	2	-5	-6	-7	-16	-24
200	125-200	0	0	-1	-6	-9	-9	-6	-8	3	3	2	-4	-5	-8	-17	-21
160	160-160	2	3	0	-5	-6	-7	-11	-12	2	3	1	-4	-5	-9	-18	-19
200	160-200	0	3	2	-6	-8	-7	-9	-10	4	3	2	-4	-5	-9	-19	-20
250	160-250	0	0	-2	-8	-10	-6	-7	-9	1	1	1	-5	-4	-8	-19	-21
200	200-200	3	4	-1	-5	-5	-7	-14	-15	2	3	-2	-6	-4	-6	-17	-24
250	200-250	-1	1	-3	-7	-7	-6	-9	-10	1	1	-1	-3	-4	-9	-20	-22
315	200-315	-2	-1	-4	-8	-9	-5	-7	-10	2	-1	-4	-6	-3	-8	-19	-26
250	250-250	1	3	-3	-4	-5	-8	-10	-11	2	4	-1	-3	-4	-9	-19	-22
315	250-315	-2	-1	-4	-8	-9	-5	-7	-10	1	-1	-4	-6	-3	-8	-19	-26
	315-315	-4	-4	-6	-2	-2	-11	-21	-25	1	1	-4	-4	-4	-7	-19	-25

Table 6

Static sound attenuation incl. end reflection, TLG-LØV

TLG-LØV	Damping [dB]							
Dim.	63	125	250	500	1k	2k	4k	8k
100	26	18	13	7	3	2	3	6
125	22	16	11	6	1	0	2	4
160	19	14	11	4	1	0	3	4
200	16	12	7	3	0	0	2	3
250	16	10	5	1	0	0	1	2
315	15	7	4	1	0	0	1	2

Table 7

Correction factor [KO], TLG-LØV

TLG-LØV	KO [dB]							
Dim.	63	125	250	500	1k	2k	4k	8k
100	-3	-1	-6	-6	-5	-5	-13	-22
125	-6	-4	-6	-6	-6	-5	-12	-23
160	1	-1	-3	-4	-5	-6	-16	-21
200	0	0	-5	-6	-5	-5	-16	-24
250	0	-5	-5	-4	-3	-7	-20	-21
315	-3	-7	-8	-6	-3	-6	-19	-26

Table 8

THROW LENGTHS

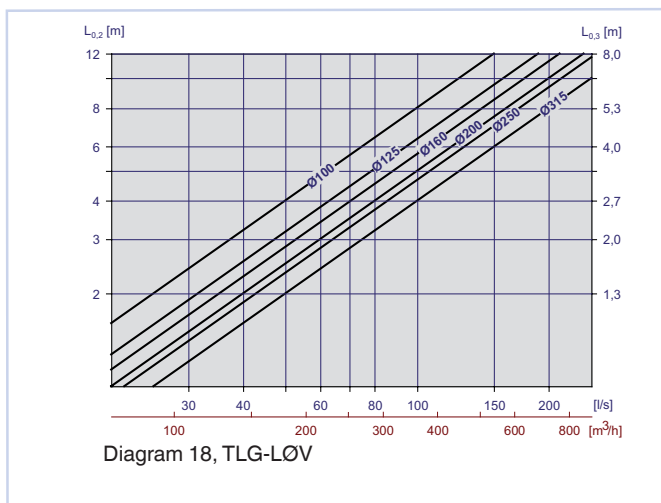

FLOW PATTERN

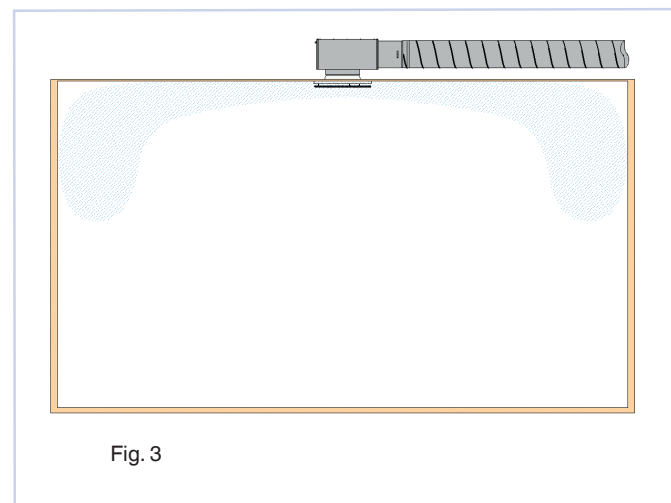

TLG-LØV

THROW LENGTHS

Velocities for the vertical jet produced by TLG-LØV-S have been measured. For isothermal conditions, the vertical throw length can be found by using diagram 19.

In the event of overheated air (heating), diagrams 20 and 21 are used to find the jet inflection point for respectively 5° or 10° overheating relative to the indoor air temperature.

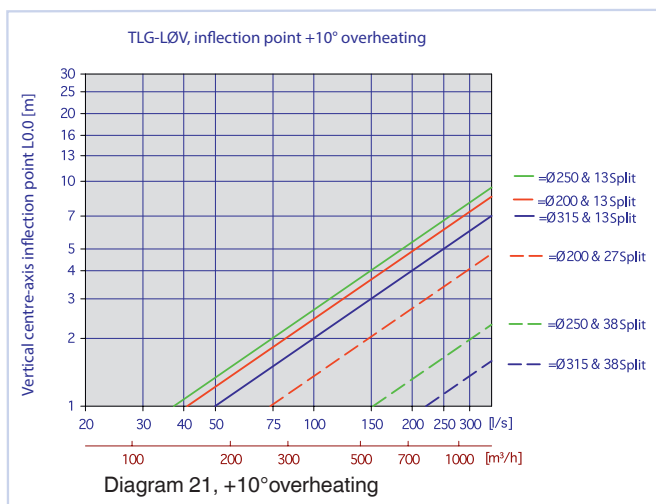
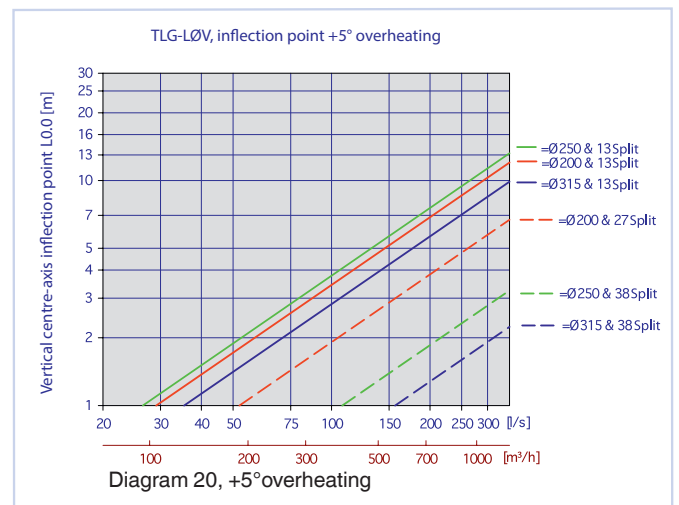
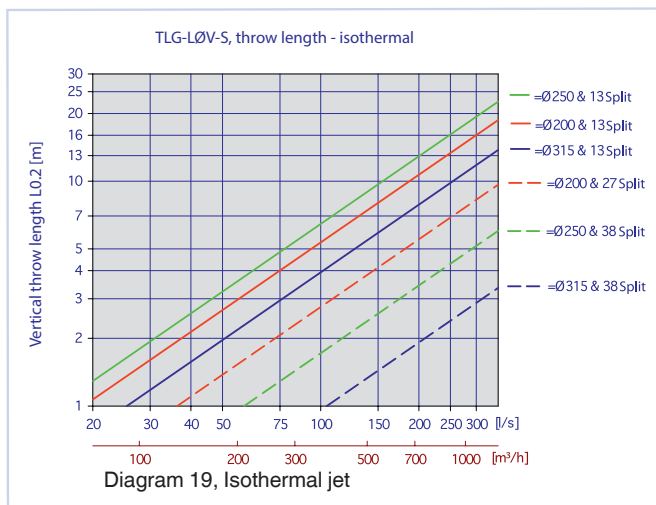

TLG-LØV

INSTALLATION

When mounted in fixed ceiling or inserted in ceiling plate, TLG-LØV is attached by means of two mounting brackets as shown in fig. 5, or the diffuser is screwed on to the box outlet. If a Luna plenum box is used, the unit is attached to the rear of the support bracket by means of threaded rod or strap (fig. 5).

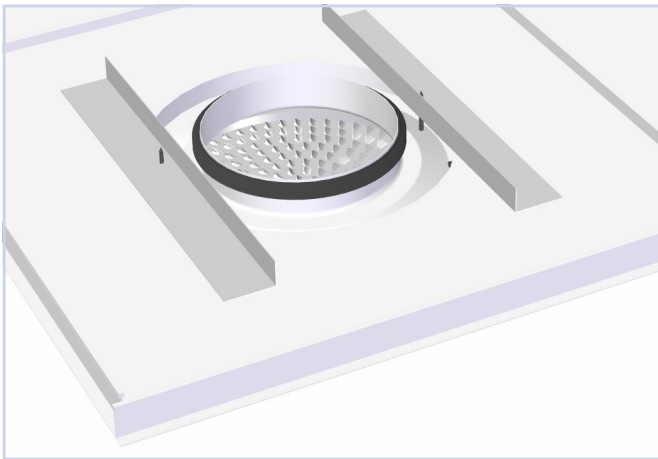

Fig. 4: Installation

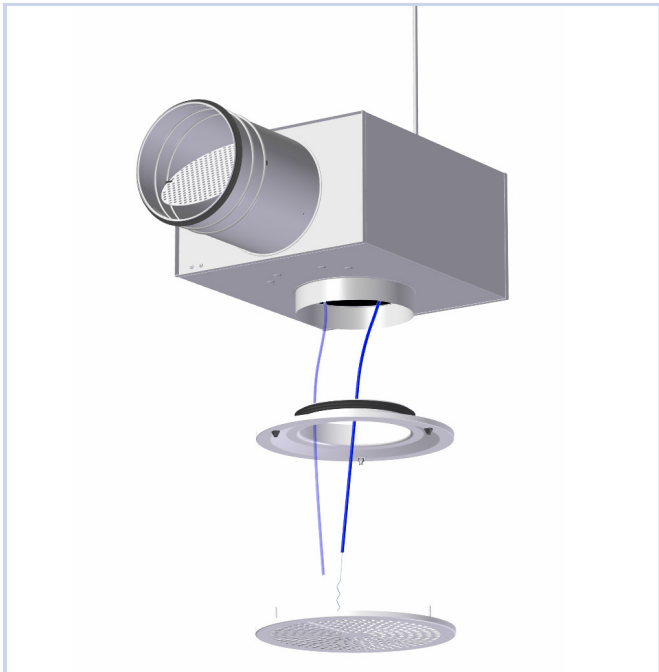

Fig. 5: Installation

TLG-LØV is developed and manufactured by:

COMMISSIONING

During commissioning, the diffuser front must be fitted. Measuring tube and adjustment wire are pulled through the slot. The damper is secured by using a clamping nut on the wire. Correction factors for calculation of air flow rates are provided on the label inside the diffuser, or can be found in our commissioning guide at our website: www.trox.no.

MAINTENANCE

The diffuser can be cleaned by using a damp cloth. When cleaning the duct network, the diffuser front must be removed in order to gain access to the duct. In Luna is used, diffuser plate and damper are to be removed in order to gain free access to the duct.

ENVIRONMENT

Enquiries regarding product declaration can be directed to our sales team, or information can be found at www.trox.no

The company reserves the right to make amendments without prior notice.