

TSI PARTICLE TECHNOLOGY

PARTICLE INSTRUMENTS

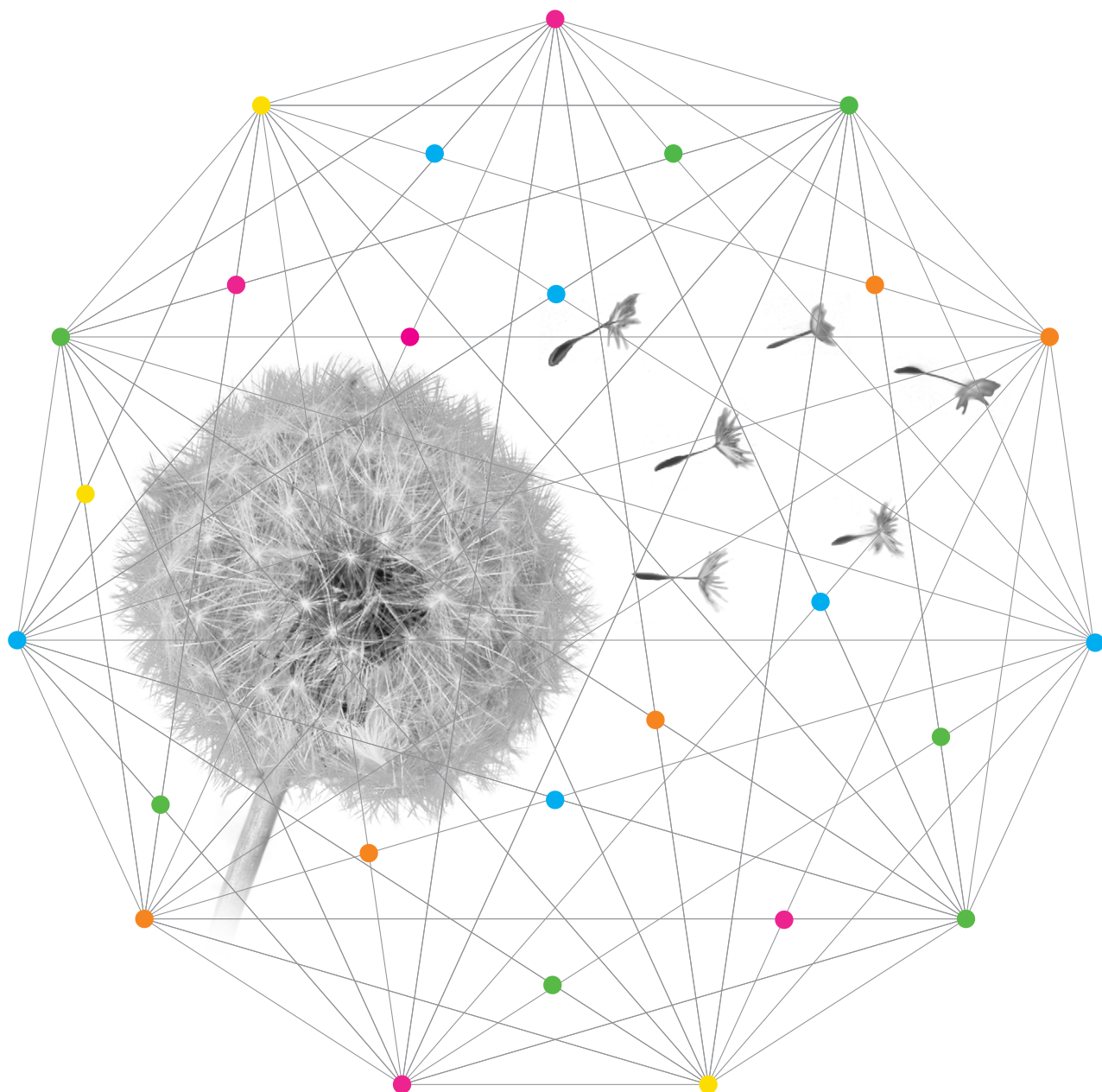

UNDERSTANDING, ACCELERATED

TSI PARTICLE TECHNOLOGY

A leading developer of aerosol research instrumentation since 1966, TSI® Incorporated offers a line of particle instruments that is second to none. Our products for sizing, counting, characterizing, generating, and dispersing aerosol particles are well known—and well respected—all over the world. We are dedicated to providing our customers with the most innovative particle technology available.

This catalog contains many proven instruments as well as our newest product offerings. The scope of this product line shows how TSI leads when it comes to performance and depth. Our intent is to offer a TSI instrument to handle most every particle research need. So browse through the following pages, then let us know how we can help you achieve your research goals.

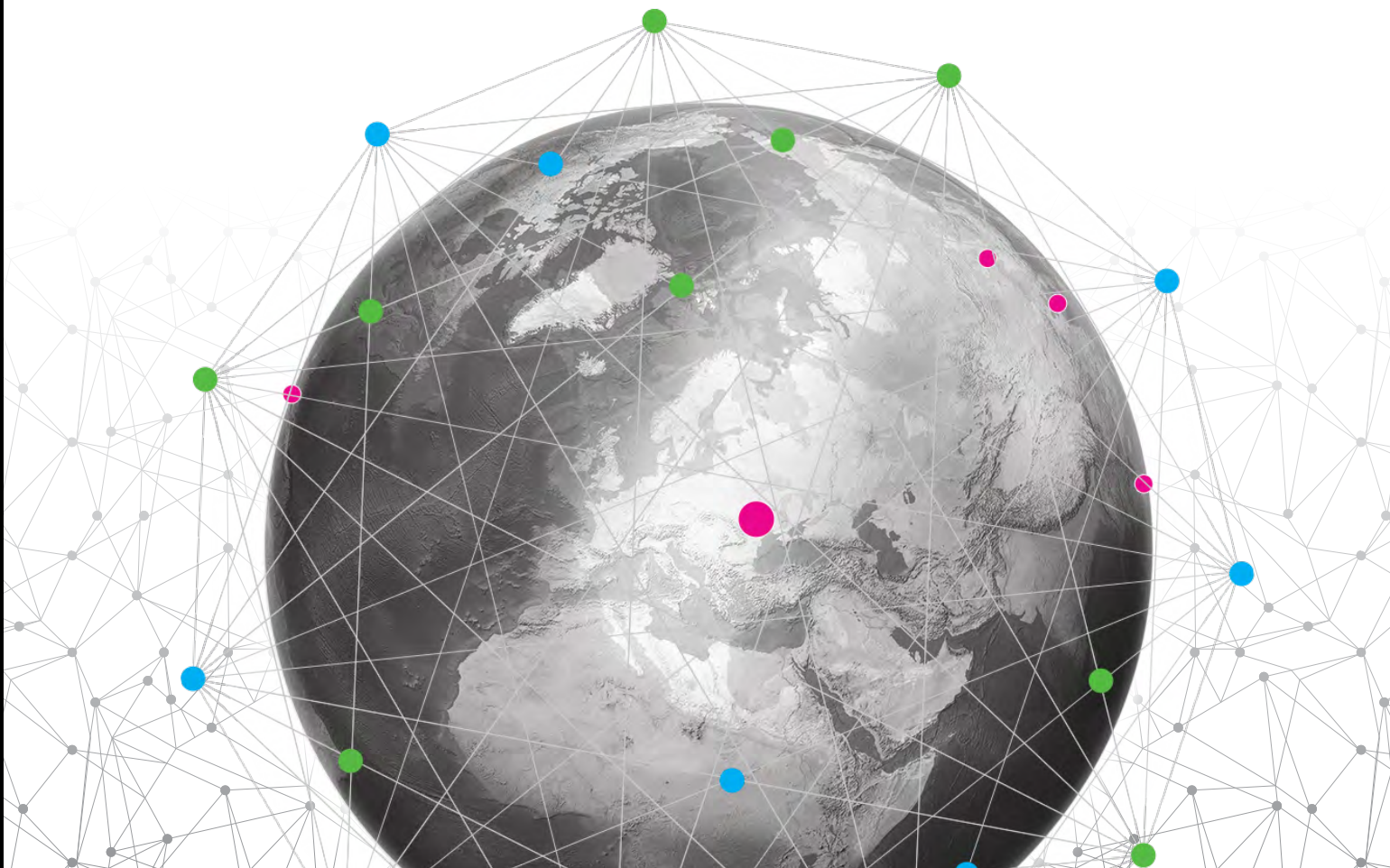

TABLE OF CONTENTS

PARTICLE SIZERS

Scanning Mobility Particle Sizer™ Spectrometers (Series 3938)	2
NanoScan Nanoparticle Sizer (3910)	3
Optical Particle Sizer (3330)	4
Aerodynamic Particle Sizer® Spectrometer (3321)	5
Aerosol Diluter (3302A)	6
Impactor Inlet (3306)	6
Laser Aerosol Spectrometer (3340)	7
Fast Mobility Particle Sizer™ Spectrometer (3091)	8

PARTICLE COUNTERS & DETECTORS

Water-Based Condensation Particle Counters (3788, 3787, 3783)	9-10
Condensation Particle Counters (3776, 3775, 3772)	10
Nano Enhancer (3777)	10
Handheld Condensation Particle Counter (3007)	11
Nanoparticle Surface Area Monitor (3550)	11
Aerosol Electrometer (3068B)	11
DustTrak™ Aerosol Monitor (8530, 8532, 8533, 8534)	12
SidePak™ Personal Aerosol Monitor (AM510)	12

AIR FILTER & RESPIRATOR TESTERS

Automated Filter Testers (8130, 8130-EN, 8127, 8127-EN, 3160)	14
Component Filter-Testing Systems (3150)	15
Laser Photometer (8587A)	16
Large-Particle Aerosol Generator (8108)	16
Respirator Leak Tester (8119)	16

ENGINE EMISSIONS

Engine Exhaust Particle Sizer™ Spectrometer (3090)	17
Engine Exhaust Condensation Particle Counter (3790A)	18
Electrical Aerosol Detector (3070A)	18
Rotating Disk Thermodiluters and Thermal Conditioner Air Supply (379020A, 379030)	19
Nanoparticle Emission Tester (3795)	20

AIR MONITORING

Ultrafine Particle Monitor (3031)	21
Environmental Sampling System (3031200)	21

PARTICLE SIZERS & IMAGING SYSTEMS

Phase Doppler Particle Analyzer (PDPA)	22
Global Sizing Velocimeter (GSV)	22

AEROSOL GENERATORS & DISPERSERS

Vibrating Orifice Aerosol Generator (3450)	24
Electrostatic Classifiers (3082)	24
Condensation Monodisperse Aerosol Generator (3475)	25
Electrospray Aerosol Generator (3482)	25
Small-Scale Powder Disperser (3433)	26
Fluidized Bed Aerosol Generator (3400A)	26
Atomizers (3076, 3079A, 9302, 9306)	27
Large-Particle Aerosol Generator (8108)	27
Oil Droplet Generator (9307-6)	27
Submicrometer Monodisperse Aerosol Generation System (3940A)	28
Supermicrometer Monodisperse Aerosol Generation System (3941)	28

INSTRUMENTS & ACCESSORIES

Nanometer Aerosol Sampler (3089)	29
Mass Flowmeter (4000 Series)	29
Diffusion Dryer (3062, 3062-NC)	29
Aerosol Neutralizers (3012, 3054, 3077, 348002)	30
Advanced Aerosol Neutralizer (3088)	30
Filtered Air Supply (3074B)	31
Flow Splitter (3708)	31
Particle Size Selector (376060)	31
Vacuum Pumps (3032, 3033)	32
Process Aerosol Monitor (3375)	32

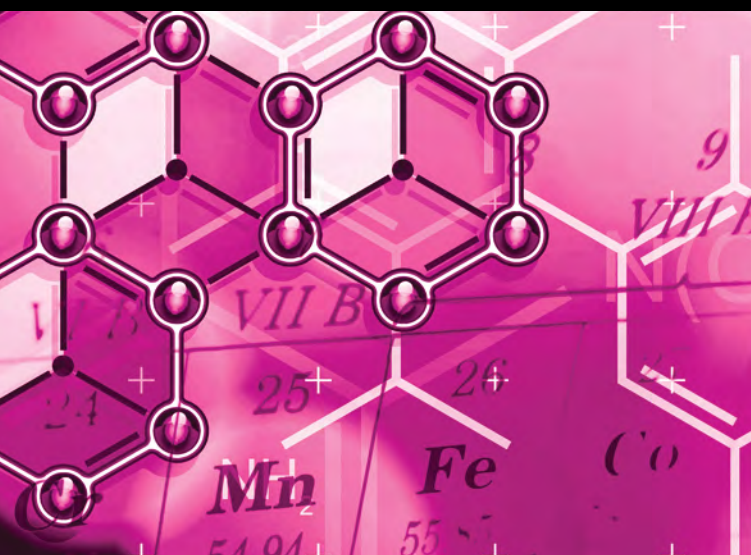
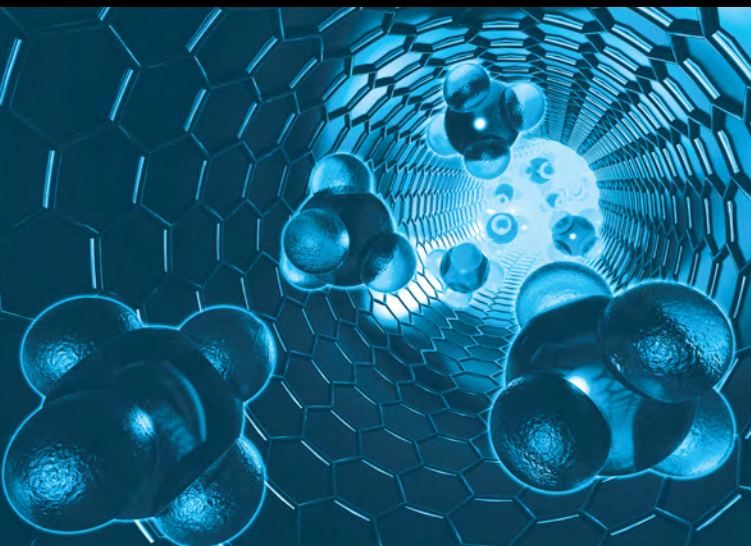
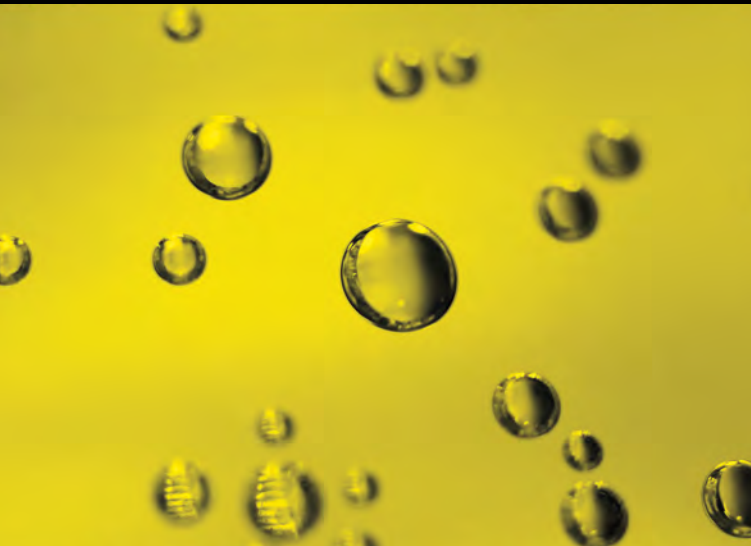

APPLICATIONS

Collectively, our line of particle instruments spans the size range from 0.002 to 2000 micrometers. This unique and comprehensive family of products is used all over the world in a variety of interesting applications.

- + Basic aerosol research
- + Nanotechnology
- + Environmental studies
- + Bio-aerosol detection
- + Pharmaceutical research
- + Health effects studies
- + Inhalation toxicology
- + Filter testing
- + Instrument calibration and standards
- + Indoor-air-quality testing
- + Industrial hygiene research
- + Energy and combustion studies
- + Diesel- and gasoline-engine emissions measurements
- + Climate change research
- + Particle formation and growth studies

Ask your TSI representative for information about specific applications, instrument operation, specifications, or new instruments not included in this catalog. To request additional literature or to place an order, call:

US & CANADA: 1-800-874-2811
EUROPE: +49 241 523030

Additional contact information appears on the back cover. Visit our web site for the most current product information available:

www.tsi.com

OPERATIONAL RANGES FOR TSI PARTICLE INSTRUMENTS

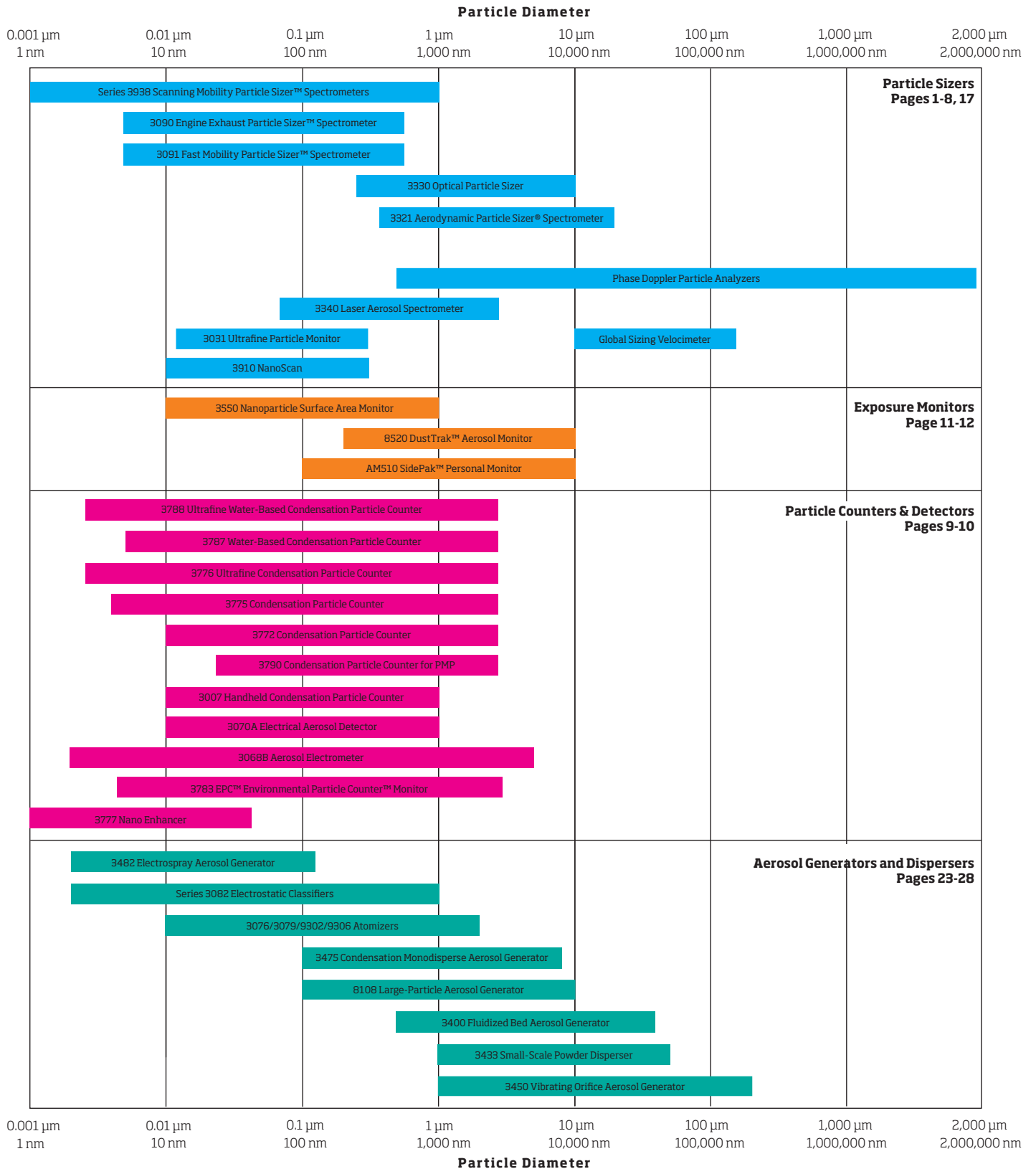

PARTICLE SIZERS



The most comprehensive selection of instruments for sizing submicrometer and supermicrometer particles.

	Sizer	Particle size range (µm)	Particle concentration (#/cm ³)	Measurement time (sec)	Resolution (total channels measured)	Channels per decade	Key feature	DMA	CPC	Condensing liquid
SMPS	3938L72	0.01 to 1.0	1 to 10 ^{7**}	10 to 600 (selectable)	Varies by model, 192 channels from 0.001 to 1.0 µm, collectively	4, 8, 16, 32, 64 (selectable)	Highest-resolution; individual components provide greatest flexibility	3081A	3772	butanol
	3938L75	0.01 to 1.0						3085A	3775	
	3938N75	0.004 to 0.15						3081A & 3085A		
	3938NL75	0.004 to 1.0						3081A	3776	
	3938L76	0.01 to 1.0						3085A		
	3938N76	0.0025 to 0.15						3081A & 3085A		
	3938NL76	0.0025 to 1.0						3081A	3787	water
	3938L87	0.01 to 1.0						3085A		
	3938N87	0.005 to 0.15						3081A & 3085A		
	3938NL87	0.005 to 1.0						3081A	3788	water
	3938L88	0.01 to 1.0						3085A		
	3938N88	0.0025 to 0.15						3081A & 3085A		
	3938NL88	0.0025 to 1.0						3086	3777 & 3772	diethylene glycol & butanol
	3938E77	0.001 to 0.05						3081A & 3086		
3938EL77	0.001 to 1.0									
NanoScan	3910	0.01 to 0.42	1 to 10 ⁶	60	13	8	Portable	Built in	Built in	isopropyl alcohol
FMPS	3091	0.0056 to 0.56	Varies by size*	1	32	16	Fast distributions	n/a	n/a	n/a
APS	3321	0.37 to 20	0.001 to 10 ⁴	1 sec to 18 hours (variable)	52	32	Aerodynamic size			
OPS	3330	0.3 to 10	1 to 3000	1 sec to 24 hours (variable)	up to 16	Variable	High res optical			
LAS	3340	0.09 to 7.5	1 to 18,000 ^a	1 sec to 60 hours (variable)	up to 99		Optical to smaller sizes			

n/a not applicable

* FMPS: 100 to 10⁷ at 5.6 nm, 1 to 10⁶ at 560 nm (1-sec average)

** Upper end of concentration determined by Aerosol Neutralizers Models 3077, 3077A, 3088 specifications

† Optical detection down to 0.37 µm; aerodynamic sizing down to 0.5 µm

‡ Up to 52 channels of aerodynamic size, up to 64 channels of fluorescence intensity, up to 16 channels of scattered-light intensity

^a Depends on sample flow

SCANNING MOBILITY PARTICLE SIZER™ SPECTROMETERS

Model 3938

Our most versatile submicrometer particle sizers provide the highest resolution and accuracy available.

Collectively, our Series 3938 Scanning Mobility Particle Sizer (SMPS™) spectrometers measure particles from 1 to 1,000 nm. They display data using up to 167 actual size channels (up to 64 channels per decade). A continuous, fast-scanning measurement technique eliminates gaps in particle-size-distribution data and allows measurements to be completed in as few as 10 seconds. SMPS spectrometers are capable of measuring a very wide concentration range, from 1 to 10,000,000 particles/cm³.

Component SMPS systems feature the new Electrostatic Classifier Model 3082 with your choice of Differential Mobility Analyzer (DMA), and a large selection of Condensation Particle Counters (CPCs). The versatility afforded by individual components enables you to select a system that best fits your sizing requirements. All components can be operated as stand-alone instruments for experiments involving monodisperse aerosol generation or counting the total number of particles.

SMPS spectrometers provide additional flexibility by allowing you to adjust the sample flow rate (from 0.2 to 3.0 L/min). This effectively enables you to select the particle size range of interest. The Electrostatic Classifier has temperature- and pressure-corrected flow rates for measurements made at elevations other than sea level. The end result is an unmatched, proven solution for research involving combustion, atmospheric aerosols, indoor air quality, filter testing, and much more.

A new color touch screen allows easy operation and provides impressive file-management capabilities. Data can be weighted by number, surface, volume, or mass. An export function allows easy transport of files to spreadsheet or other applications for customized data handling. Additional software capabilities include multiple-scan averaging, a buffer for comparing data sets, multiple-charge correction for up to 10 charges, programmable start/stop times, automatic file storage and printout options, and impactor- and CPC-efficiency correction factors.

SMPS Accessories (available separately)

- 379020A Rotating Disk Thermodiluter (page 19)
- 390069 Data Merge Software (page 5)
- 3089 Nanometer Aerosol Sampler (page 29)
- 3088 Soft X-Ray Neutralizer (page 30)

Upgrade your older SMPS™ system.

Customers with series SMPS 3936 spectrometers can upgrade to a Series 3938 system. Keep the CPC and aerosol neutralizer, then let us modify your old DMA for use on a Model 3082 platform! Purchase of the Series 3938 software upgrade is required. Call your TSI representative for additional requirements.

Thermodiluter and Data Merge Software

The Rotating Disk Thermodiluters complement TSI particle sizers and counters when used for particle emission measurements, especially when sampling, diluting, and conditioning exhaust particles from diesel and spark-ignition engines. See page 19 for a description of the thermodiluters and accessories.

The Data Merge Model 390069 Software module works with our Aerosol Instrument Manager software and simplifies the tedious task of merging SMPS and Aerodynamic Particle Sizer® (APS™) data files. Data sets can be averaged, merged, and fitted to multimodal distributions, and graphs and tables can be generated easily.

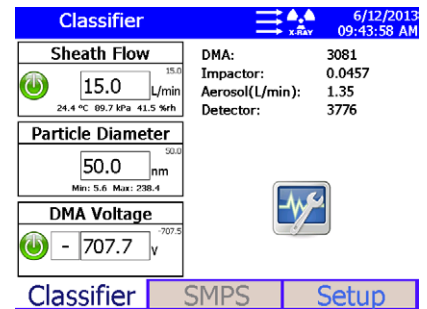

SMPS component systems give you the highest-resolution particle size data.

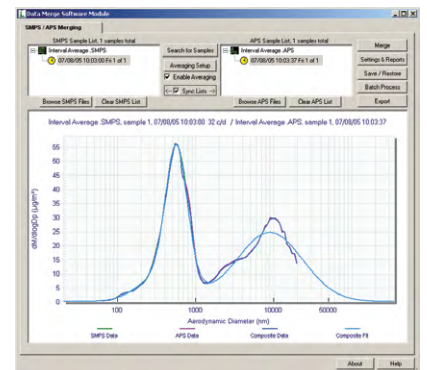

Data Merge model 390069 Software allows you to merge and fit SMPS and APS data files to create and display a wide particle size range.

NANOSCAN NANOPARTICLE SIZER

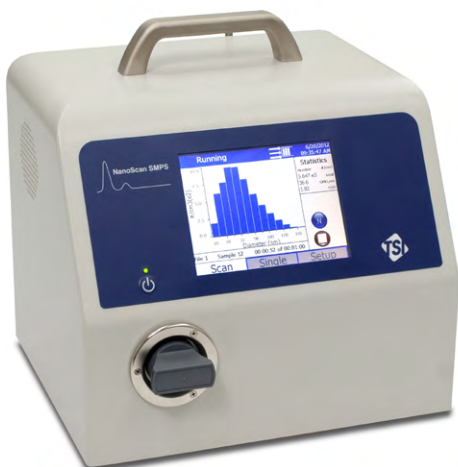

Model 3910

Affordable, portable nanoparticle sizer for particles down to 10 nm.

The TSI NanoScan SMPS opens the door to routine nanoparticle size measurements. This revolutionary sizer fits a TSI SMPS™ Spectrometer into an affordable, portable package that is about the size of a basketball. Easy to use, lightweight, and battery-powered, NanoScan SMPS enables investigators to collect valuable nanoparticle size data from more sites, including size distributions down to 10 nm for concentrations up to 1,000,000 particles/cm³ in selectable SCAN or SINGLE measurement modes. Derived from TSI core technologies, the NanoScan SMPS is an innovative, cost-effective solution for real-time nanoparticle size measurements.

Data collection begins with a touch of the instrument display - no need for a dedicated computer to set up the instrument or save data. The user interface is intuitive and easy for new users to operate. NanoScan SMPS displays real-time number, surface area, or mass size distributions, concentrations, and statistics. From the front panel, users can program start time, number of samples, and other parameters. A full suite of instrument diagnostic data can be viewed from the Setup Screen.

In addition to nanoparticle size distributions, the NanoScan SMPS can collect second-by-second concentration data at a single mobility diameter. If the nanoparticle source of concern generates 50 nm particles, it is possible to easily monitor 50 nm mobility diameter with 1 second time resolution to keep a real-time record of concentration levels.

Combine the NanoScan SMPS and the Optical Particle Sizer Model 3330 to measure three orders of size magnitude from 10 nm to 10 μm using affordable MIM software in concert with portable, real-time instruments.

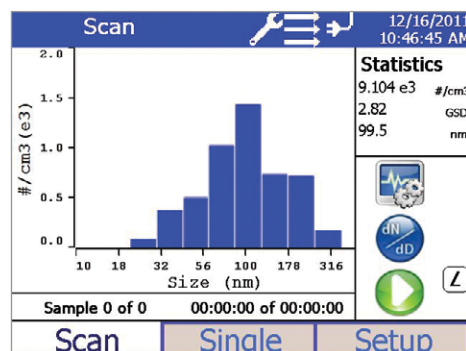

Screen shot of NanoScan SMPS during nanoparticle size distribution measurement.

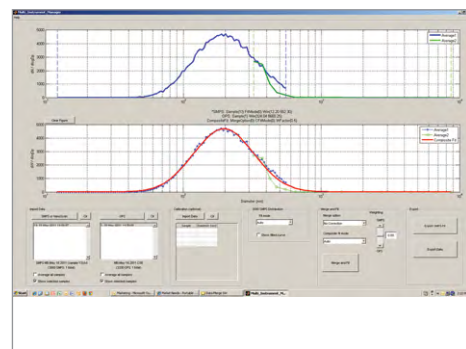

OPTICAL PARTICLE SIZER



Model 3330

Easy-to-use particle sizer for particles 0.3 - 10 µm in size.

Optical Particle Sizer 3330 (OPS) is a light, portable unit that uses single-particle counting technology to provide fast, accurate measurement of particle concentration from 0 to 3,000 particles/cm³ and particle size distribution for 0.3 - 10 µm in up to 16 channels. Backed by over 40 years of aerosol instrumentation design experience, the OPS uses state-of-the-art optics with 120° light collection and sophisticated electronics processing resulting in precision, high-quality data. The affordable, easy-to-use package features a color touch screen with an intuitive user interface. Rigorous factory calibration standards ensure measurement accuracy.

In addition to improving the core measurement fundamentals of OPCs, the Model 3330 includes the ability to enter the index of refraction and shape factor of the aerosol into the software to provide more accurate size distributions. The size boundaries can be adjusted using both real and imaginary components of refractive index. A unique density for every size channel can also be entered into the software to further improve mass concentration measurements.

The Model 3330 is manufactured at TSI's ISO 9001 certified facility. It is calibrated using NIST traceable PSL spheres and TSI's accredited Electrostatic Classifier and Condensation Particle Counters. PSL is the industry-wide calibration aerosol of choice because it has properties close to many real world aerosols and is traceable to national standards throughout the world. Each OPS that leaves the factory is built for longevity, backed by TSI's commitment to quality, and supported by our worldwide network of committed TSI professionals.

OPS Accessories (available separately)

- 3332-10 10:1 Diluter
- 3332-100 100:1 Diluter
- 8535 Environmental Enclosure



OPS Model 3330 status screen.

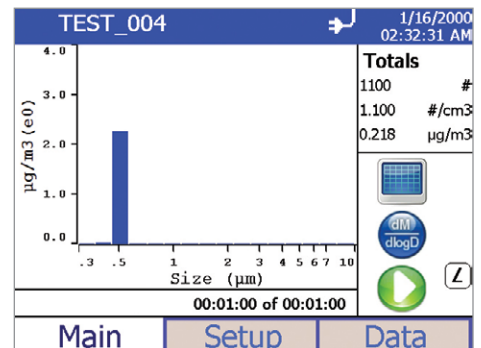

Mass size distribution for 0.49 µm ± 9 nm classified PSL spheres.



Environmental Enclosure

AERODYNAMIC PARTICLE SIZER® SPECTROMETER



APS software has advanced instrument-control and data-handling features. Above, a graph of aerodynamic diameter is displayed with particle-size and statistics tables.

Model 3321

The only way to determine a particle's true airborne behavior is to measure its aerodynamic diameter.

Aerodynamic measurements account for differences in particle size, shape, and density. This is crucial when determining if a particle will penetrate a filter, be removed by a cyclone, or be deposited in the lung. The Aerodynamic Particle Sizer (APS™) spectrometer has been used successfully for over 20 years in laboratory and field applications to provide high-resolution, real-time aerodynamic measurements in the range from 0.5 to 20 μm . Our latest models also measure light-scattering intensity in the equivalent optical size range of 0.37 to 20 μm . By providing paired data for each particle, the APS opens up exciting new possibilities for aerosol scientists interested in studying the makeup of an aerosol.

The Model 3321 APS spectrometer uses a patented, double-crest optical system for unmatched sizing accuracy. It also includes a redesigned nozzle configuration and improved signal processing. The result is greater small-particle sizing efficiency, improved accuracy of mass-weighted distributions, and near elimination of false background counts. The Aerosol Instrument Manager® software provides advanced data-handling capabilities.

APS Accessories (available separately)

- 3302A Aerosol Diluter (page 6)
- 3306 Impactor Inlet (page 6)
- 3433 Small-Scale Powder Dispenser (page 26)
- 390069 Data Merge Software (below)

Data Merge Software

The Model 390069 Data Merge Software module works with our Aerosol Instrument Manager software and simplifies the tedious task of merging Scanning Mobility Particle Sizer™ (SMPS™) and APS data files. Data sets can be averaged, merged, and fitted to multimodal distributions, and graphs and tables can be generated easily.

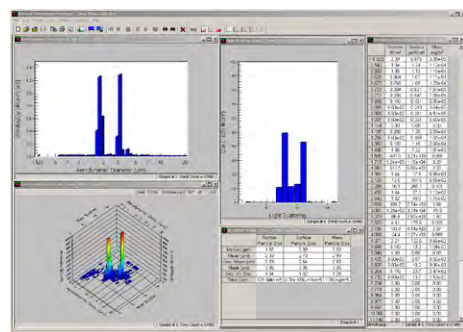

Three graphs showing aerodynamic diameter, side scatter, and correlated data are displayed on this screen simultaneously.

United States Patent Number 5,561,515

AEROSOL DILUTER



3302A

Conditions high-concentration aerosols for use with the APS spectrometer.

This diluter reduces particle concentrations of high-concentration aerosols, providing a representative sample that meets the input requirements of the Aerodynamic Particle Sizer® (APS™) spectrometer (page 5). The 3302A achieves dilution ratios of 100:1 and 20:1 using easy-to-change capillary tubes. Two diluters in a tandem configuration provide dilution ratios as high as 10,000:1.

Engineered to provide very low particle loss in the 0.5 to 10 μm size range, the Aerosol Diluter is totally self-contained and requires no outside power or compressed gas. Durable construction and simple maintenance procedures translate into years of trouble-free operation. Model 3302A works with both old and new APS spectrometers. (APS sold separately)

IMPACTOR INLET



Model 3306

Collects a size-segregated sample for mass or chemical analysis while making APS measurements.

An accessory for our Aerodynamic Particle Sizer spectrometer (page 5), the 3306 combines a single-stage impactor with a filter. It takes a size-segregated sample and directs a diluted (80:1), representative portion of the initial test aerosol into the particle sizer for measurement. The inlet aerosol passes through a single-stage impactor (2.5 or 4.7 μm , 50% cut size) and is collected with an after-filter for later mass or chemical analysis. Model 3306 includes two inlet throats: one for standard applications; the other for pharmaceutical research. (APS sold separately)

Accessory (available separately)

3033 Vacuum Pump (page 32)

LASER AEROSOL SPECTROMETER

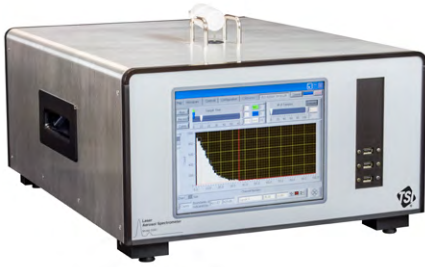

Model 3340

Higher-sensitivity, high-resolution general-purpose particle sizer.

TSI's Laser Aerosol Spectrometer 3340 is a high-sensitivity, high-resolution, general-purpose aerosol particle sizer. This 'turn on and measure' instrument allows users to easily measure a size range of 0.09 (90 nm) to 7.5 μm . Complete size distributions are measured in less than a second by simply powering up and sampling.

The 3340 is a handy tool to have for monitoring your filters or your processes, measuring in a lab, or sampling on field campaigns. It's just as useful as your primary aerosol tool, but the 3340 can also provide valuable supplemental information to aerosol measurements based on other sizing techniques (i.e., SMPS, APS, CPC, FMPS, etc.).

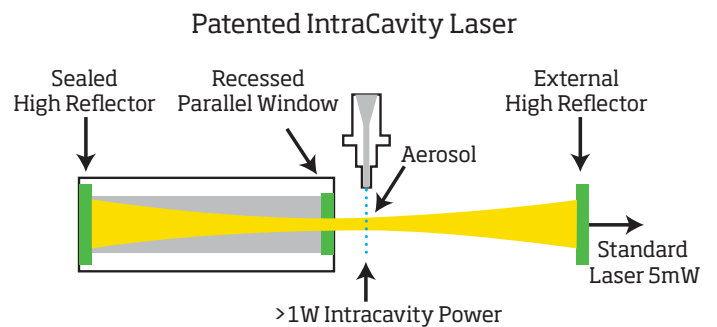
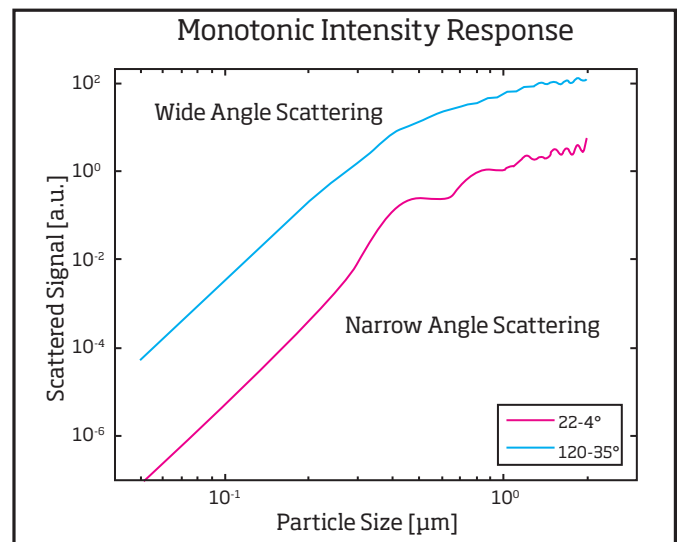

FAST MOBILITY PARTICLE SIZER® SPECTROMETER

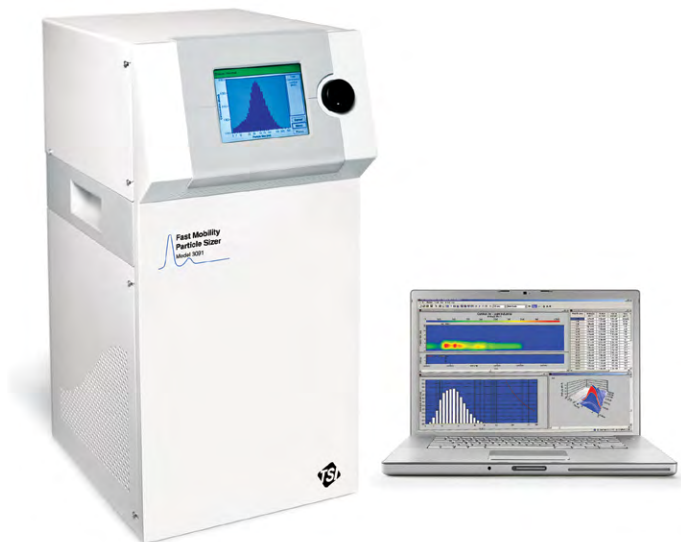

Model 3091

Measures size distribution and number concentration of rapidly changing, submicrometer aerosol particles in real time.

The Fast Mobility Particle Sizer (FMPS™) spectrometer measures particles in the range from 5.6 to 560 nm, offering a total of 32 channels of resolution (16 channels per decade). This submicrometer particle sizer uses an electrical mobility measurement technique similar to that used in the SMPS spectrometers. However, instead of a CPC, the Model 3091 FMPS spectrometer uses multiple, low-noise electrometers for particle detection. This produces particle-size-distribution measurements with 1-second resolution, providing the ability to visualize particle events and changes in particle size distribution in real time.

The Model 3091 operates at a high flow rate (10 L/min) to minimize diffusion losses of ultrafine and nanoparticles. It operates at ambient pressure to prevent evaporation of volatile and semivolatile particles. It requires no consumables. Plus, it uses an efficient, unipolar charger to eliminate the need for a radioactive neutralizer.

The FMPS is easy to transport, set up, and operate. It can be configured to measure single or multiple runs continuously for up to 12 hours. Its large, color VGA display and built-in control knob provide easy access to instrument functions, set-up menus, and data displays. Software highlights include a variety of graphing options, including 3-D playback of size distribution and concentration versus time, data export capabilities, and the ability to input individual effective densities per channel to calculate a continuous output of total particulate mass.

All of these features make the FMPS spectrometer appropriate for a variety of applications, especially particle formation and growth studies, indoor-air-quality measurements, environmental research, inhalation toxicology studies, urban canyon studies, and transient emission studies from stacks, boilers, and wood burners.

Developed by TSI Incorporated under license from Airel, Ltd. of Tartu, Estonia.

U.S. Patent No. 7,230,431

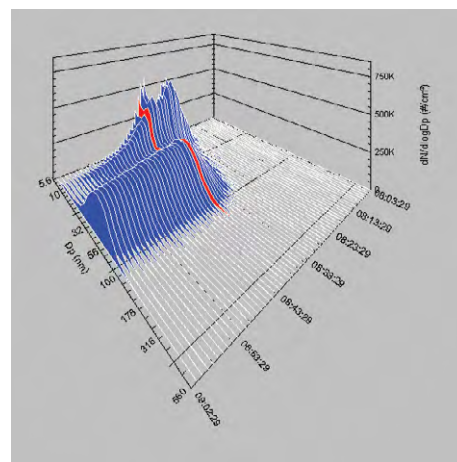
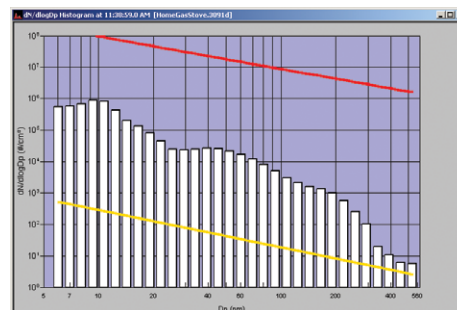

FMPS software enables you to view a variety of parameters. Here, the same data are pictured in a bimodal concentration histogram and a 3-D size distribution vs. time.

PARTICLE COUNTERS AND DETECTORS



TSI leads when it comes to instruments for particle counting, aerosol detection, and particle concentration measurement.

ULTRAFINE CONDENSATION PARTICLE COUNTER

Model 3776

Detects particles down to 2.5 nm with extended single particle counting up to 300,000 particles/cm³.

The UCPC is designed primarily for researchers interested in airborne particles smaller than 20 nm. It uses a special sheath-air flow design that improves response time and increases counting efficiency. It features single particle counting with continuous, live-time coincidence correction for accurate measurements, an anti-spill design, water-removal capability, built-in data logging and storage capabilities, a removable memory card, and USB and Ethernet connectors. This UCPC is ideally suited for atmospheric and climate research, particle formation and growth studies, combustion and engine research, and nanotechnology applications.

CONDENSATION PARTICLE COUNTER

Model 3775

This CPC detects particles down to 4 nm at concentrations up to 10,000,000 particles/cm³.

The Model 3775 CPC is a general-purpose counter that accurately measures concentration over a wide range. It features two detection modes: extended single-particle counting with continuous, live-time coincidence correction and photometric counting for concentrations up to 10,000,000 particles/cm³. The Model 3775 also features an improved transition between the two counting modes, anti-spill design, water-removal capability, data logging and storage capabilities, a removable memory card, and USB and Ethernet ports. We recommend this CPC for basic aerosol research, environmental monitoring, health effects studies, inhalation and exposure studies, combustion research, and more.

Model	3788	3787	3783	3776	3775	3772	3007	3777
Minimum Particle Size (nm, 50% efficiency)	2.5	5	7	2.5	4	10	10	1.3
Upper Concentration Limit (particles/cm ³)	4 x 10 ⁵	2.5 x 10 ⁷	10 ⁶	3 x 10 ⁵	10 ⁷	10 ⁴	10 ⁵	3 x 10 ⁵
Response Time (sec, 95% response)	~0.25†	~0.25†	<3	<1†	<4†	<3	<9	<5
Aerosol Flow Rate (cm ³ /min)	300	1,000	120	50	300	1,000	100	2,500
Condensing Liquid	Water			n-Butyl Alcohol			Isopropanol	Diethylene Glycol
SMPS [†] Compatibility	Yes		No	Yes			No	Yes
Data Logging Capability	Yes		No	Yes				Yes*
AIM Software				Yes				Yes*
Display Type	Touchscreen w/ Graphics			Color VGA		LCD	LCD	LCD
Vacuum Source				Internal		External	Internal	External

† High-flow mode

‡ Series 3936 Scanning Mobility Particle Sizer spectrometers

* Includes data logging capability and AIM software when used in conjunction with 3772.

CONDENSATION PARTICLE COUNTER

Model 3772

A compact, full-featured CPC that detects particles down to 10 nm.

The Model 3772 uses single particle counting with continuous, live-time coincidence correction to accurately measure concentrations up to 10,000 particles/cm³. It is ideally suited for applications that do not require measurement of high concentrations, including basic aerosol research, filter and air-cleaner testing, particle counter calibration, particle shedding and component testing, and more. This CPC also features an anti-spill design, water-removal capability, built-in data logging and storage, removable memory card, and USB and Ethernet ports. It requires an external vacuum pump (sold separately).

EPC™ ENVIRONMENTAL PARTICLE COUNTER

Model 3783

Real-time, Ultrafine Particulate (UFP) number concentrations.

Targeted at unattended monitoring, the EPC™ monitor provides quantitative UFP concentration data to supplement mass-based and FRM equivalent methods. This freshly engineered, water-based condensation particle counter detects ultrafine particles down to 7 nm for single-particle counting up to 10,000,000 particles/cm³. The EPC™ monitor provides robust field performance and requires minimal maintenance, making it a good choice for indoor and outdoor ambient monitoring as well as many other applications that require 24/7 operation.

CPC Accessories (available separately)

376060	Particle Size Selector (page 31)
376061	Additional diffusion screens for Particle Size Selector (Qty. 12)
3032	Vacuum Pump for 3772 and 3783 CPCs (page 32)

NANO ENHANCER

Model 3777

Particle detection down to 1nm.

The 1nm Nano Enhancer Model 3777 is designed for researchers interested in the formation of aerosol particles, in size ranges below conventional condensation particle counters (CPCs). The Model 377 Nano Enhancer enables the detection of particle down to 1nm, making it ideal for a wide variety of studies including particle formation and growth, atmospheric and climate aerosols and nanotechnology research. The Model 3777 has been optimized for use with TSI's One-DMA Differential Mobility Analyzer model 3086, creating a Scanning Mobility Particle Sizer (SMPS) spectrometer capable of sizing over the 1nm to 50nm size range, with minimal diffusion losses.

GENERAL PURPOSE WATER-BASED CPC

Model 3787

A fast SMPS™ spectrometer-compatible WCPC that detects down to 5 nanometers.

TSI's Model 3787 General Purpose Water-Based Condensation Particle Counter (GP-WCPC) can detect airborne particles down to 5 nm in diameter using state-of-the-art, water-based condensation particle counting technology. With a high sample flow rate of 0.6 LPM, the versatile Model 3787 is a good choice for low concentration measurements, yet it is also capable of measuring up to 250,000 particles/cm³ using exclusively single particle counting. The carefully designed flow path, high flow rate, and sophisticated electronics used in the Model 3787 result in a rise time of < 1/3 second.

NANO WATER-BASED CONDENSATION PARTICLE COUNTER N-WCPC

Model 3788

World's fastest CPC - counting down to 2.5 nanometers.

TSI's N-WCPC Model 3788 is designed for investigators interested in detecting the smallest nanoparticles down to 2.5 nm. This sophisticated particle counter uses state-of-the-art, water-based condensation technology and features the highest activation energy and lowest detectable particle size of the WCPC family. With less than 0.1 second rise time, the Model 3788 is the fastest CPC commercially available and its high sample flow rate provides low diffusion losses and low Poisson noise. Other important elements include a thermodynamically optimized growth region and enhanced optical and detection design for impressive signal to noise ratios. The Model 3788 can be used as a stand-alone counter measuring up to 400,000 particles/cm³ (using single particle counting) or as a component of a TSI SMPS™ spectrometer.

HANDHELD CONDENSATION PARTICLE COUNTER



Model 3007

Portable, battery-powered CPC that detects particles down to 10 nm.

The Model 3007 is a hand-held CPC intended for measuring ultrafine particles in a wide variety of applications. Its small size and ergonomic design make it the best choice for short-term outdoor and indoor-air-quality monitoring, nanoparticle work area surveys, and mobile aerosol research. This highly portable CPC weighs only 1.7 kg (3.8 pounds)!

NANOPARTICLE SURFACE AREA MONITOR



Model 3550*

Measures lung-deposited surface area of inhaled particles.

Recent research has shown that the surface area of nanoparticles is highly correlated to exposure-related adverse health effects. The Model 3550 indicates the surface area of nanoparticle aerosols that deposit in the lung. The reported measurements correspond to the ICRP lung deposition curves for the tracheobronchial (TB) and alveolar (A) regions of the human respiratory tract. The Model 3550 measures particles in the size range of 10 to 1,000 nm. This is an important instrument for research in the fields of inhalation toxicology, health effects, and epidemiology, and for measuring and monitoring workplace exposure. Model 3550 offers user-selectable measurement modes, comprehensive software, continuous operation, a wide dynamic range, and high time resolution.

*U.S. Patents 6,544,484 and 7,812,306

AEROSOL ELECTROMETER



Model 3068B

Measures net charge or concentration of aerosol.

Our Aerosol Electrometer has been updated to make use of new technologies that were developed for our Electrical Aerosol Detector and Engine Exhaust Particle Sizer™ spectrometer. It measures the total net charge on aerosol particles from 0.002 to 5 μm at a user-selectable flow rate from 1 to 10 L/min. When paired with a TSI Electrostatic Classifier, the electrometer measures the number concentration of monodisperse aerosol. This configuration is used primarily for calibrating and testing particle instruments like CPCs. Data are presented on the front-panel display in real time and also as an analog voltage output for data recording. The electrometer is compatible with the Aerosol Instrument Manager® software. An external vacuum pump is required (sold separately).



Models 8530, 8532, 8533 & 8534

Simply leaves everyone else in the dust.

The DustTrak™ II and DRX Aerosol Monitors are battery-operated, data-logging, light-scattering laser photometers that give you real-time aerosol mass readings. These monitors measure aerosol contaminants such as dust, smoke, fumes and mists. They use a sheath air system that isolates the aerosol in the optics chamber to keep the optics clean for improved reliability and low maintenance. Suitable for clean office settings as well as harsh industrial workplaces, construction and environmental sites, and other outdoor applications.

Ideal applications include industrial/occupational hygiene surveys, indoor-air-quality investigations, outdoor environmental monitoring, fugitive emissions monitoring, site perimeter monitoring, dust control operations, baseline trending and screening, engineering control evaluations, point source monitoring, engineering studies, remote monitoring, and process monitoring.

Model AM510

A personal, battery-operated laser photometer that measures and records worker exposure to dust.

The SidePak™ Personal Aerosol Monitor is a rugged, lightweight, belt-mounted laser photometer that weighs as little as 454 grams (16 ounces). A built-in sampling pump allows the use of a variety of size-selective inlet conditioners. Model AM510 includes TSI's Smart Battery Management System™, which includes long-running NiMH or alkaline battery packs and indicates run time in minutes remaining. An easy-to-read display shows real-time aerosol mass concentration and 8-hour, time-weighted average (TWA). Data logging and long battery life make the AM510 ideal for work shift or extended sampling.

	SidePak AM510	DustTrak II Model 8530	DustTrak II Model 8532	DustTrak DRX Model 8533	DustTrak DRX Model 8534
Particle Size Range		0.1 to 10 µm		0.1 to ~15 µm	
Aerosol Concentration Range	0.001 to 20 mg/m ³	0.001 to 400 mg/m ³	0.001 to 400 mg/m ³	0.001 to 150 mg/m ³	0.001 to 150 mg/m ³
Measurement Output	Single Mass Concentration (PM ₁₀ , Respirable, PM _{2.5} , PM ₁)	Single Mass Concentration (PM ₁₀ , Respirable, PM _{2.5} or PM ₁)		Simultaneous Size-Segregated Mass Fractions for PM ₁₀ , PM _{2.5} , Respirable, PM ₁₀ and Total. All Displayed.	
Gravimetric Reference Filter	No	Yes	No	Yes	No
Data Logging	31,000 data points, 21.5 days at 1 min	5 MB of on-board memory (>60,000 data points); 45 days at 1 minute logging interval.			
Type	Personal	Desktop	Handheld	Desktop	Handheld

AIR FILTER & RESPIRATOR TESTERS



3160



8127/8130

Our automated air filter and respirator testers are known for simple, reliable operation.

Component systems are also available.

	8127 ^a	8130 ^a	3160
Measurement Application	Loading and Quality Control Tests		Penetration vs. Particle Size
Maximum Efficiency	99.999%		99.999999%
Aerosol Type ^b	DOP, PAO, DEHS, Paraffin, and other Oils	DOP, PAO, DEHS, Paraffin, and other Oils or NaCl	DOP, PAO, DEHS, and other Oils or NaCl
Aerosol Generation	Atomizer		Atomizer with Classifier
Count Median Diameter ^c	0.2 µm (Oil)	0.2 µm (Oil) or 0.075 µm (NaCl)	N/A
Geometric Standard Deviation ^c	<1.6 (Oil)	<1.6 (Oil) or < 1.86 (NaCl)	<1.3
Flow Rate	15 to 100 L/min		5 to 100 L/min
Resistance	0-150 mm H ₂ O (0-1470 Pa)		
Particle Detection	Light Scattering Photometer		Condensation Particle Counter
Typical Test Length ^d	10 sec		30 sec to 20 min
Data Reporting	Alpha-Numeric Display and RS-232		PC with Integrated Software
Operation	Stand Alone Tester/Automated Production Lines		Stand Alone Tester
Compliance	US 42 CFR part 84, EN 143, JMOL, ISO 23328-1		EN 1822 parts 3 and 5

a) EN versions (for equivalent results to EN 143 standard) available (8127-1-EN, 8130-1-EN)

b) Aerosol abbreviations: DOP (dioctyl phthalate), PAO (polyalpha olefin), DEHS (di-ethylhexyl sebacate)

c) EN version CMD and GSD are different. See 8127/8130 spec sheet for more info

d) Efficiencies higher than 99.9999% require longer than typical testing times

AUTOMATED FILTER TESTER

Models 8130 & 8130-EN

Filter testers for commercial respirator and military mask testing.

Model 8130 is designed for simple, fast, automated operation. That is why it excels in quality-control and production-testing applications. It can also be used for certification testing of all respirator filter categories in accordance with US 42 CFR part 84, as well as for other standards around the globe. For customers who need to test according to European standard EN 143, TSI now offers the Model 8130-EN tester.

Models 8130 and 8130-EN can measure efficiencies up to 99.999%, or penetrations as low as 0.001%, using either polydisperse oil or sodium chloride aerosol. Both testers produce oil aerosol without heat, so a variety of oils can be used. Dual light-scattering photometers provide simultaneous upstream and downstream particle concentration measurements to ensure fast, repeatable results. A touch-panel display makes these testers extremely easy to use, so very little operator training is needed. On-screen menus enable operators to easily change test parameters to accommodate special requirements. An internal microprocessor controls the tester and calculates and displays filter penetration, resistance value, and flow rate. Additionally, it performs self-diagnostic checks during operation and automatically zeros the tester between measurements to ensure accurate, stable, reproducible results.

AUTOMATED FILTER TESTER

Models 8127 & 8127-EN

Oil-only filter testers for commercial respirator and military mask testing.

Model 8127 includes all of the features of our Model 8130, except it is an oil-only tester. It can be used for quality control and certification testing in accordance with US 42 CFR part 84, as well as for other standards around the globe. For customers who need to test according to European standard EN 143, TSI now offers the Model 8127-EN tester.

Models 8127 and 8127-EN can measure efficiencies up to 99.999%, or penetrations as low as 0.001%, using polydisperse oil aerosol. Both testers produce oil aerosol without heat, so a variety of oils can be used. Dual light-scattering photometers provide simultaneous upstream and downstream particle concentration measurements to ensure accurate, fast, repeatable results.

AUTOMATED FILTER TESTER

Model 3160

Determines penetration vs. particle size of filters and filter media.

Model 3160 is the most advanced automated tester available for challenging filters and filter media with submicrometer aerosols. It can be used to test both low- and high-efficiency filters and filter media, up to 99.999999% efficient (eight 9's), or penetrations down to 0.000001%. The 3160 uses a bank of atomizers and the TSI Electrostatic Classifier to challenge a filter or filter media with size-controlled, monodisperse particles. Two Condensation Particle Counters (CPCs) simultaneously count the upstream and downstream particles and computer software calculates the penetration value. Filters can be sequentially challenged with up to 20 different monodisperse particle sizes from 15 to 800 nm. The penetration value for each particle size is calculated. At the end of a test, the 3160 generates a curve of penetration vs. particle size and produces a summary of test results, including the most penetrating particle size (MPPS). Test results can be automatically saved in a Microsoft® Access® data base and downloaded into Microsoft® Excel®.

Model 3160 complies with EN 1822-3 and provides the most complete information on filter penetration available from any filter tester. You'll find it invaluable for product development and quality control.

COMPONENT FILTER-TESTING SYSTEMS

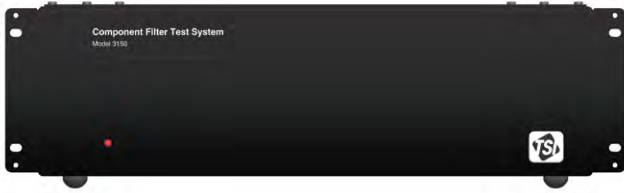

Model 3150

Off-the-shelf solutions to your custom air filter testing needs.

For the wide range of flow rates and particle sizes needed to meet the requirements of the many filter-testing standards and research needs, an automated tester is not always practical. Building a filter test system from components is often the best way to satisfy your measurement needs. TSI has developed the CFTS as an easy-to-use system to integrate all the necessary parts of this type of system.

The Component Filter Test System (CFTS) Model 3150 from TSI consists of software and a hardware module to provide an off-the-shelf solution for all your custom filter-testing needs. Pre-configured to work with TSI's world-class detectors and sizers, the CFTS provides a platform for numerous filter test applications.

Because filters are used for a wide variety of applications and are tested to many different filter test standards, you need a filter-testing system that is flexible enough to change to meet these various standards. The CFTS system is designed for this flexibility. It measures flow using a variety of techniques and controls blowers to achieve the required flow. It has multiple ports used to read temperature, pressure, and relative humidity, then make flow corrections and log sensor data for test reports. Whether designing a new test duct or updating an existing system, the CFTS provides an easy-to-use system with the flexibility to meet your filter-testing needs.

CFTS is structured as a core platform which controls the filter test. Its graphical user interface is used to define the test layout and procedures as well as being your interface for running the test. The CFTS has drivers to communicate with the particle instruments and is the interface for reading sensors and controlling flow. During testing, it collects, saves, and exports the data needed for test reports. No longer is custom software required for every component change.

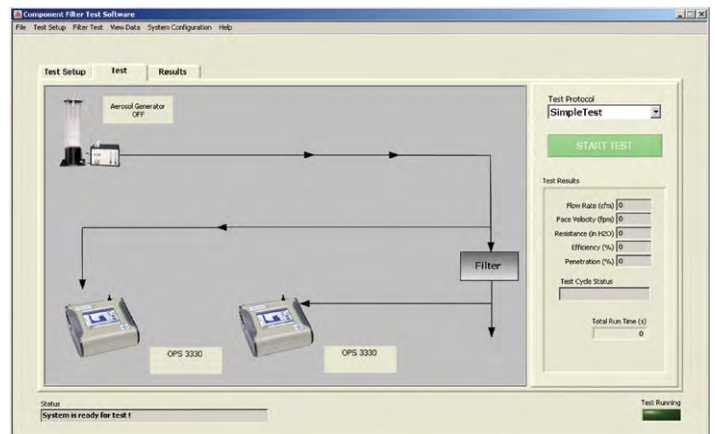

CFTS software screen shot.

LASER PHOTOMETER



Model 8587A

A compact, reliable photometer for customized filter testing.

This photometer features a reliable laser diode that produces constant laser power, so aerosol concentration measurements remain stable over a long period of time. A sheath-air design keeps the optics clean for low background levels and minimal maintenance requirements. The 8587A uses an internal switching valve to measure both the upstream and downstream aerosol concentration. A special high-speed "purge" mode shortens the purge time when switching between upstream and downstream measurements. A simple command set can be incorporated into your LabVIEW® program to give you complete flexibility in test protocol and database management. All of these features combine to make the 8587A ideally suited for custom filter testing applications.

LARGE-PARTICLE AEROSOL GENERATOR

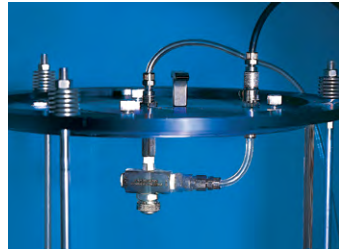

Model 8108

Generates high-concentration aerosols up to 10 µm in diameter.

The Large-Particle Aerosol Generator produces highly concentrated aerosol over a wide particle-size range, from 0.1 to 10 µm. Designed for easy cleaning, this generator produces potassium chloride (KCl) and other aerosols. Model 8108 meets the requirements of ASHRAE 52.2 for KCl test aerosol and can also be used for ISO/TS 11155-1:2001 filter efficiency testing. It is an ideal aerosol generator for fractional efficiency testing of general ventilation filters and automotive cabin-air filters.

RESPIRATOR LEAK TESTER



Model 8119

Turns Models 8127 and 8130 into respirator leak testers.

This accessory enables Models 8127 and 8130 to perform fast, easy, after-maintenance leak tests on full-face and half-mask air-purifying respirators. After installing the 8119, simply mount the respirator on the headform and scan the respirator with the hand-held probe. Test critical areas like eye-lens seals and exhaust valves. Audible and visual alarms are triggered if the aerosol concentration inside the mask exceeds a preset level.



ENGINE EMISSIONS

ENGINE EXHAUST PARTICLE SIZER™ SPECTROMETER

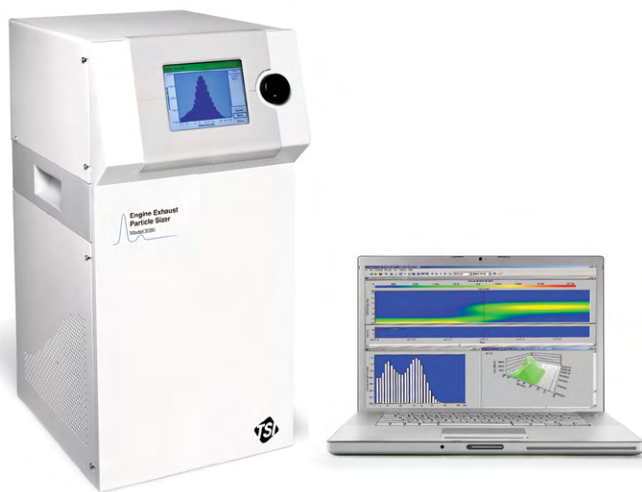

Model 3090

The best tool for measuring transient particle emissions and characterizing exhaust after-treatment devices.

The Engine Exhaust Particle Sizer (EEPS™) spectrometer measures the size distribution of engine particle emissions in the range from 5.6 to 560 nm with the fastest time resolution available (10 times per second!). Users can visualize and study the dynamic behavior of emissions that occur during transient test cycles, such as changes in engine speed, torque, or load. They may also measure emissions that occur during the first few seconds of a cold start or during regeneration of a particle trap or diesel particulate filter (DPF).

Measurements are displayed with high size resolution (32 total channels, 16 channels per decade). The EEPS spectrometer operates over a wide particle concentration range, which makes it well-suited for measuring upstream and downstream of a particle trap or DPF to determine soot loading and removal efficiency.

The EEPS operates at ambient pressure to prevent evaporation of volatile and semivolatile particles, requires no consumables, and uses an efficient, unipolar charger to eliminate the need for a radioactive neutralizer. Users can select from multiple matrices tailored to specific aerosols for more accurate measurement.

Ease of operation is a key feature of this instrument. All components, including the vacuum source, are housed in a single cabinet that weighs just 32 kg (~70 lbs). Just turn on the power and allow the instrument to warm up. A microprocessor corrects for volumetric flow and barometric pressure automatically. This will maintain calibration and provide accurate particle size distribution information. The EEPS also features an external "start" input trigger for remote operation, two analog inputs to log and correlate other engine parameters, and four user-configurable analog outputs to integrate emission measurements with the test cell host computer.

EEPS software allows users to display measurements in a variety of graphical and tabular formats, including 3-D viewing of size distribution and concentration versus time. These can be replayed for a unique "movie" view of the entire engine cycle, or you can zoom in on a period of interest. The software includes a data export capability and allows users to input individual effective densities per particle size channel to calculate a continuous output of total particulate mass.

EEPS Accessories (available separately)

- 379020A-30 Rotating Disk Diluter with Thermal Conditioner Air Supply (page 19)

The EEPS spectrometer was developed by TSI Incorporated under license from Airel, Ltd. of Tartu, Estonia. Additional assistance was provided by the University of Minnesota Center for Diesel Research.

U.S. Patent No. 7,230,431

ENGINE EXHAUST CONDENSATION PARTICLE COUNTER



Model 3790A

The particle number (PN) concentration benchmark for ECE Regulations 83 and 49.

The Engine Exhaust Condensation Particle Counter (EECPC) accurately measures PN concentration of exhaust emissions. In fact, the GRPE Particle Measurement Programme (PMP) concluded that PN measurements using a CPC plus thermodilution are 20 times more sensitive and much less variable than the traditional method (i.e., gravimetric filter analysis). As a result, the measurement of solid PN emissions has been included in Regulation 83 (Euro 5) for certification of new passenger vehicles with diesel engines, and later for Regulation 49 (EURO 6) for heavy-duty engines.

Model 3790 EECPC is fully compliant for light-duty vehicle certification in accordance with all Regulation 83 requirements. The Model 3790 EECPC incorporates a wide assortment of design improvements and features such as anti-spill design, condensate removal, removable saturator for ease of maintenance, built-in microprocessor with USB, RS-232 and Ethernet communication interfaces, touch-panel membrane keys and a display that enables instrument set-up, viewing particle concentration and count data, interrogating instrument status, and data storage capabilities. The EECPC includes our Aerosol Instrument Manager® software. An external vacuum pump is required - sold separately.

ECE Regulations 83 and 49 mandate that only the number concentration of solid particles are measured. TSI offers the Rotating Disk Diluter with Thermal Conditioner Air Supply to eliminate or suppress the formation of volatile compounds so that the EECPC only counts solid particles. Together, the Models 3790 and 379020A-30 fulfill the proposed solid PN sampling and measurement requirements, as shown in Figure 1.

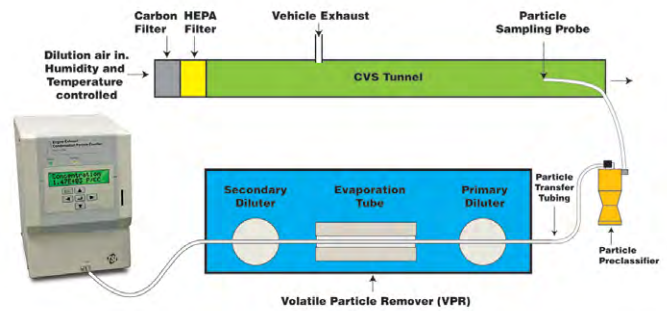

Figure 1: Proposed Regulation 83 particle sampling and measurement.

EECPC Accessories (sold separately)

3032	Vacuum Pump, 115 VAC (page 32)
3032-EC	Vacuum Pump, Europe only (page 32)
3032-1	Vacuum Pump, 230 VAC (page 32)
379020A-30	Rotating Disk Diluter with Thermal Conditioner Air Supply (page 19)

ELECTRICAL AEROSOL DETECTOR



Model 3070A

A simple, low-cost tool for measuring particle emissions second-by-second.

The Electrical Aerosol Detector (EAD) is a robust instrument that provides highly repeatable, real-time measurements in the range from 10 to 1000 nm. It operates over a wide concentration range and requires no working fluid or consumables. When combined with a TSI Rotating Disk Thermodiluter, the EAD becomes a real-time solid PN detector. These features make the EAD ideally suited to evaluate particle emissions during transient engine operation, to characterize efficiency of exhaust after-treatment devices, and for on-board emissions testing.

ROTATING DISK THERMODILUTERS AND THERMAL CONDITIONER AIR SUPPLY

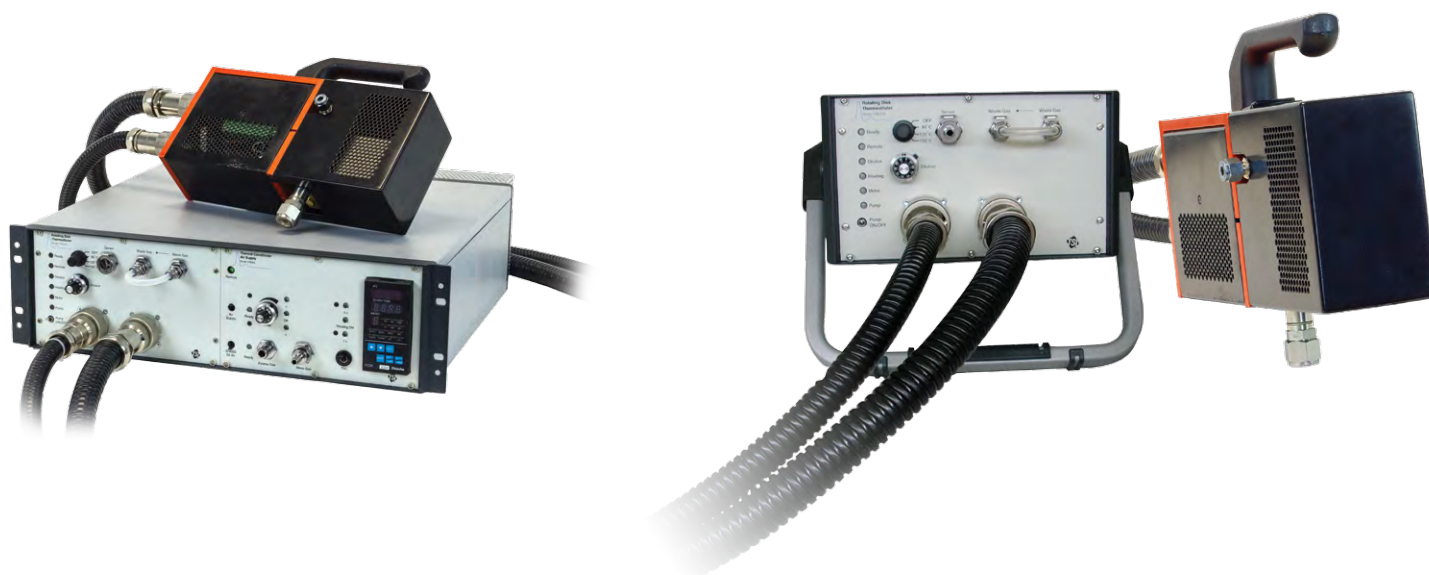

Models 379020A & 379030

Dilute and condition combustion sources to preserve the original particle size distribution and number concentration for accurate measurements.

TSI Model 379020A Rotating Disk Thermodiluter is highly regarded in the field of particle emission measurement, especially for sampling, diluting, and conditioning exhaust emissions from diesel and spark-ignition engines, as well as for performing stack emission studies.

The Model 379020A features a separate diluter head and control unit, which allows the sample to be diluted and thermally conditioned at the point of measurement (i.e., tailpipe, CVS tunnel, or stack). It also features a variable dilution ratio that is adjustable from 15:1 to 3000:1 and selectable heated diluter temperatures up to 150°C to avoid measurement of condensed volatile materials.

In order to measure only the solid particle emissions, it is necessary to further thermally condition the sample to eliminate the semi-volatile and volatile fractions. TSI offers the Model 379030 Thermal Conditioner Air Supply that can be combined with the Model 379020A. It uses an evaporation tube to heat the sample up to 400°C, which effectively eliminates volatile compounds that may have formed in the exhaust as it cools or becomes diluted. Rotating Disk Thermodiluters and accessories can be used with all of our submicrometer particle sizers, especially the EEPSTM and SMPSSTM spectrometers, all of our CPCs, and the EAD.

Thermodiluters

379020A	Rotating Disk Thermodiluter
379020A-30	Rotating Disk Diluter with Thermal Conditioner Air Supply

Thermodiluter Accessories (sold separately)

379030	Thermal Conditioner Air Supply
1137021	Hardware to run 3090 with 379020A
379025	Housing for Diluter Head
379027	Cyclone (PM2.5)
379032A	Digital Control Unit

These instruments are produced in Switzerland by Matter Aerosol.

NANOPARTICLE EMISSION TESTER



General Purpose Test Mode Display Output: Live strip chart of total solid particle number concentration with 1 hz frequency and cumulative statistics.

Model 3795

Portable, accurate and Regulatory-compliant.

The TSI Nanoparticle Emission Tester (NPET) Model 3795 is a portable, accurate instrument capable of measuring total solid particle number emissions from a variety of diesel-powered sources, including construction machinery, buses, stationary gensets, and more. Featuring a robust, user-friendly design, the NPET can be used in the field by researchers, regulatory inspectors, and maintenance personnel alike.

Official Certification Testing

The Nanoparticle Emissions Tester fully meets Swiss Regulation 941.242 for the periodic certification of diesel-powered machinery equipped with a DPF.

Solid Particle Measurements

Sampling from combustion sources is often challenging due to the presence of volatile material. Volatile components are extremely sensitive to sampling conditions and can grow existing particles and form new particles through condensation. By evaporating and oxidizing volatile components and particles, the NPET Model 3795 measures only the remaining solid particles.

A Sophisticated Instrument in a Simple Package

The Nanoparticle Emissions Tester combines a traditionally complex system of components into a portable, robust measurement tool. The five key design components include:

- Sampling probe
- Preconditioner
- Recirculating dilution flow conditioner: A silica desiccant dryer and two high capacity HEPA filters.
- Volatile particle remover: A catalytic stripper heated to 350° C evaporates, and oxidizes volatile components.
- Particle counter: An isopropanol-based CPC provides accurate, direct measurement of particle number emissions.

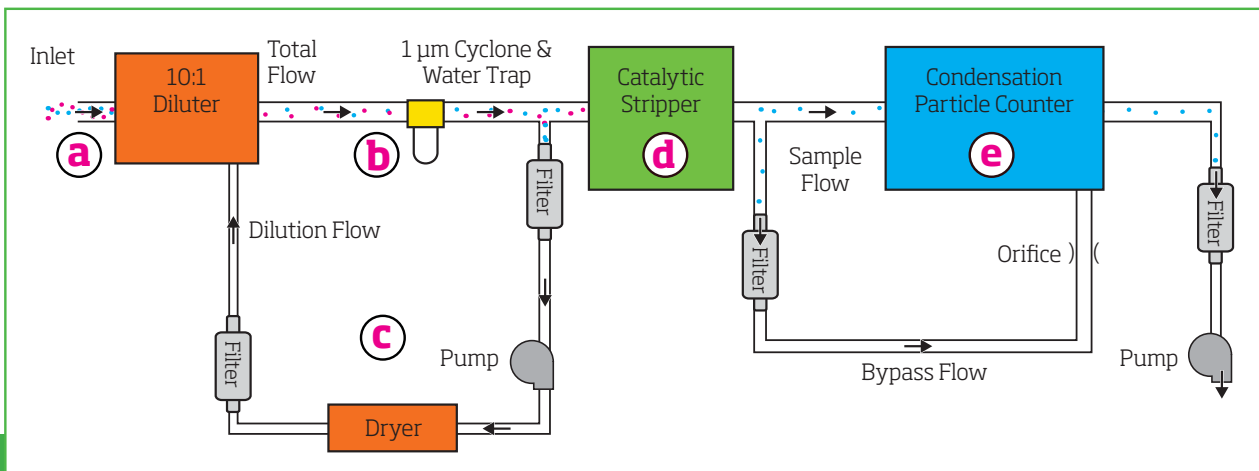



AIR MONITORING

ULTRAFINE PARTICLE MONITOR



Model 3031

Provides continuous size distribution and number concentration data for long-term air quality monitoring.

The Model 3031 Ultrafine Particle (UFP) Monitor has been specifically designed for long-term air-quality monitoring networks. It operates continuously, 24-hours a day, for months on end, with minimal maintenance and requires no working fluids. The UFP Monitor has no radioactive source, so there are no special licensing requirements and no restrictions on its use or where it can be installed. The Model 3031 fits into a standard 19-inch, rack-mount cabinet, which allows it to be easily installed into existing roadside and urban-air-quality monitoring stations. A bench-top version of this instrument, the Model 3031-1, is available for laboratory or mobile applications.

ENVIRONMENTAL SAMPLING SYSTEM



Model 3031200

Provides representative sampling and proper conditioning of ambient submicrometer aerosol for accurate size distribution and particle number concentrations.

The Model 3031200 Environmental Sampling System is an accessory for use with a wide variety of TSI particle sizers and counters, including the Ultrafine Particle Monitor, Scanning Mobility Particle Sizer™ spectrometers, and Condensation Particle Counters. The Model 3031200 consists of a standard PM10 inlet, a sharp-cut PM1 cyclone, a flow splitter, and a Nafion® dryer. Combine these components with your choice of appropriate-length sampling tubes and vacuum source for easy setup in the field.

PARTICLE SIZERS & IMAGING SYSTEMS



PHASE DOPPLER PARTICLE ANALYZER

Model PDPA

A noninvasive instrument that measures particle, droplet, or bubble size.

Phase Doppler technique allows for the sizing of spherical particles (typically spray droplets, bubbles, and hollow or solid spheres). Along with size information, this technique obtains particle velocity. Typical limits for common configurations are 0.5 μm on the lower end and 5 mm on the upper end.

The Phase Doppler Particle Analyzer (PDPA) uses the principles of light-scattering interferometry. It requires no calibration because particle size and velocity are dependent only on the laser wavelength and optical configuration. PDPA technique does not depend upon scattered-light intensity and is not subject to beam attenuation or deflection that occurs in dense particle and combustion environments. Consequently, the technique works well in dense spray and combustion measurements.

PDPA systems are used in a wide variety of disciplines around the world, including combustion research, aircraft icing research, inkjet printer development, industrial sprays research, spray drying, characterization of metered-dose inhalers, droplet size and velocity measurements of medical nasal sprays, and characterization of paint sprays.

GLOBAL SIZING VELOCIMETER

Model GSV

For simultaneous size and velocity measurements.

GSV is an imaging-based system that provides simultaneous measurements of the size and velocity of individual droplets, bubbles, or spherical particles in an area. It uses a laser light sheet to illuminate a region of the particle field. Imaging-based measurement methods feature the significant advantage of providing thousands of individual droplet or particle size/velocity measurements from a single image. The simultaneous nature of the measurements makes advanced analysis (such as size and velocity correlations) simple, making it an attractive measurement solution for a variety of industrial and research applications.

AEROSOL GENERATORS AND DISPERSERS



3450



3082L

Collectively, our generators and dispersers produce particles in the range of 0.002 to 200 micrometers.

Model	Monodisperse Generators				Powder Generators		Polydisperse Generators					
	3450	Series 3080	3475	3482	3400A	3433*	3076*	3079A*	9302*	9306*	9307/9307-6	8108
Particle size range (µm)	1 to 200 [†]	0.002 to 1.0	0.1 to 8.0	0.002 to > 0.1	0.5 to 40 [†]	1.0 to 50 [†]	0.01 to 2.0 (nominal 0.3-µm count mean diameter)					0.1 to 10.0
Particle concentration	<10 ³ /cm ³	<10 ⁵ /cm ³	>10 ⁶ /cm ³	>10 ⁷ /cm ³	10 to 100 mg/m ³	0.3 to 40 [§] mg/m ³	>10 ⁷ /cm ³	>10 ⁸ /cm ³	>10 ⁷ /cm ³	>10 ⁷ /cm ³	>10 ⁷ cm ³	10 ⁴ /cm ³
Nominal flow rate (L/min)	30 to 80 ^{**}	≤2	3.5 to 4	0.25 to 3	5 to 15	5	3.0 to 3.5	1.0 to 4.2	6.5	6.5 to 39 ^{††}	30/1000	140

*May be used to disperse monodisperse solid particles such as PSL. †Large sizes require optional orifices. ‡Aerodynamic diameter. §High concentrations require optional high-speed motor.
 **Includes dilution air; nominal dispersion air flow rate is 1.5 L/min. ††Flow rate at 25-psig inlet pressure; higher pressures and flow rates possible

VIBRATING ORIFICE AEROSOL GENERATOR

Model 3450

Creates uniform, monodisperse particles in the range of 1 to 200 μm with unmatched accuracy.

The Vibrating Orifice Aerosol Generator (VOAG) is a highly accurate source of monodisperse particles in the range of 1 to 200 μm . Using a variety of solutes and solvents, the VOAG creates solid or liquid aerosol particles uniform in size, shape, density, and surface characteristics. The VOAG produces uniform particles by controlling the breakup of a liquid jet. It delivers a consistent volume of liquid using a constant-flow syringe pump. Its consistency and accuracy make this aerosol generator an effective choice for applications like basic aerosol research, instrument calibration, and product design and development. Standard orifices are included for small particle sizes; additional orifices are available for producing larger particles.

VOAG Accessories (available separately)

3054	Aerosol Neutralizer (page 30)
3074B	Filtered Air Supply (page 31)
393520	10- μm orifice (one included with instrument)
393530	20- μm orifice (two included with instrument)
393540	35- μm orifice
393550	50- μm orifice
393560	100- μm orifice
393590	0.5- μm filters, 13-mm diameter (quantity of 100, one set included with instrument)

The Model 3450 VOAG is part of the Model 3941 Supermicrometer Monodisperse Aerosol Generation System described on page 28.

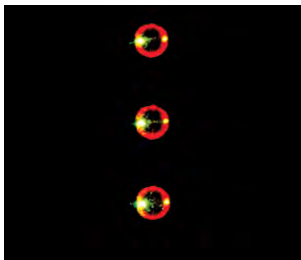

A micro-orifice inside the generation head vibrates during operation, producing highly uniform particles in solid or liquid form. (photo courtesy of Prof. Richard K. Chang)

ELECTROSTATIC CLASSIFIERS

Model 3082

Primary-standard instruments that produce highly monodisperse, submicrometer aerosols.

The Series 3082 Electrostatic Classifiers are primary-standard aerosol instruments that give you highly monodisperse, submicrometer aerosol from a polydisperse source. Our classifiers have been used in a variety of aerosol-generation or particle-sizing applications with highly repeatable results.

Electrostatic Classifiers neutralize polydisperse aerosol and use a differential mobility analyzer (DMA) to classify and strip out a narrow, predictable size. TSI provides a choice of three DMA columns. You can purchase any column and interchange them on the same platform, giving you unprecedented versatility. The platform is available separately for use with your own DMA.

Particles produced with our Electrostatic Classifiers range in size from 0.001 to 1.0 μm . For monodisperse aerosol generation, simply set the software for the desired particle size.

Electrostatic Classifiers

3082	Classifier Platform with out Aerosol Neutralizer, but no DMA or Impactor Inlet
3081A	Long DMA (0.01 to 1 μm , included with 3080L)
3085A	Nano DMA (0.002 to 0.15 μm , included with 3080N)

Electrostatic Classifiers are included in our SMPs™ systems. Model 3080L is part of the Model 3940 Submicrometer Monodisperse Aerosol Generation System. DMA columns are interchangeable. For restrictions, consult local authorities on the use of Aerosol Neutralizers. The Nano DMA was developed in cooperation with the University of Minnesota Particle Technology Laboratory and Gerhard Mercator University. Refer to United States Patent Number 6,230,572.



DMA's contain highly polished surfaces for high-resolution particle size classification (left). The Series 3080 offers a choice of two DMA's (right).

CONDENSATION MONODISPERSE AEROSOL GENERATOR



Model 3475

Generates high-concentration, monodisperse aerosols quickly and accurately.

The Condensation Monodisperse Aerosol Generator (CMAG) is a condensation-type instrument that produces high-concentration, monodisperse aerosol particles. It is well-suited for challenging HEPA and ULPA filters, seeding wind tunnels, conducting inhalation studies, or other applications requiring monodisperse particles in high concentrations.

The CMAG generates liquid or solid particles from a variety of oils, waxes, and other materials, in concentrations greater than 10^6 particles/cm³. It generates monodisperse particles in the range of 0.1 to 8 μ m and operates at a flow rate of 3.5 to 4 L/min. Particles can be fluorescently or radioactively labeled. A coil heater inside the saturator and a condensation-nuclei bypass filter provide rapid response when changing aerosol size. The CMAG can operate for long periods without interruption. Aerosol may be monitored for size and concentration using the optional Process Aerosol Monitor.

CMAG Accessories (available separately)

3375 Process Aerosol Monitor (page 32)

Please specify voltage requirements. Models 3475 and 3375 are produced in Germany by Topas GmbH.

ELECTROSPRAY AEROSOL GENERATOR



Model 3482

Produces monodisperse particles as small as 2 nanometers.

The Electro Spray Aerosol Generator (EAG) uses a patented technique to produce high concentrations of monodisperse, submicrometer particles in the range from 2 to >100 nm in diameter. The EAG produces such small, uniform particles by pushing a charged liquid solution or suspension through a capillary tube and exerting an electrical field on the liquid at the capillary tip. The electrical field pulls the liquid from the capillary, forming individual droplets. Air and CO₂ mixed with the droplets evaporate the liquid, and the remaining particles are neutralized by an ionizer. The result is a neutralized, monodisperse aerosol. Applications for the EAG include instrument calibration, nanometer-sized powder dispersion, macromolecular analysis, and nano-aerosol studies.

EAG Accessories

3482-spump	Syringe Pump
3982-Auto(C)	Autosampler and HPLC Pump
3982-autopump	Standalone HPLC Pump

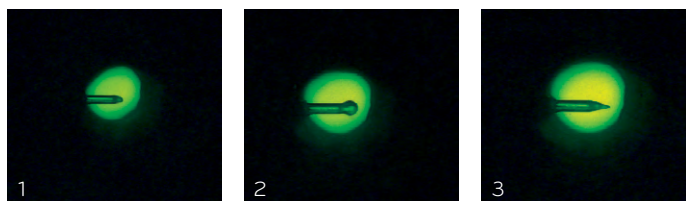

The Electro spray produces particles down to 2 nm. A viewport allows you to watch the capillary tip during operation: (1) no liquid flow, (2) with liquid flow but no electrical field, and (3) with liquid flow and an electrical field. The third view illustrates stable operation.

SMALL-SCALE POWDER DISPERSER



Model 3433

Disperses small quantities of powder for powder sizing applications.

The Small-Scale Powder Disperser (SSPD) aerosolizes very small quantities of powder by lifting particles from a turntable using a venturi aspirator. The turntable rotates at variable speeds, controlling aerosol concentrations from 0.3 to 4.0 mg/m³ (up to 40 mg/m³ with optional high-speed motor). Shear forces created in the SSPD are sufficient to deagglomerate most dry particles in the size range of 1.0 to 50 μm.

A selection of optional turntables is available to meet special needs, including one designed to redisperse airborne material collected on 25 and 35-mm membrane filters used during environmental or exposure monitoring. Because it disperses only a small amount of sample, the SSPD is great for studies involving rare, expensive, or hazardous materials. It also effectively disperses polystyrene latex (PSL) spheres used to calibrate measurement instruments. If you want to measure the size distribution of powders, the SSPD can be paired with our Aerodynamic Particle Sizer® spectrometer (page 5).

SSPD Accessories (available separately)

3074B	Filtered Air Supply (page 31)
1030737	Standard turntable (one included with instrument)
1030770	Turntable preloaded with 5-, 7-, 10-, 15-, 20-, and 30-μm PSL particles
1030771	Membrane-filter turntable
1030772	V-groove turntable
1030779	High-speed motor for output up to 40 mg/m ³

FLUIDIZED BED AEROSOL GENERATOR



Model 3400A

Disperses powders in stable concentrations for dust experiments or particle seeding.

The Fluidized Bed Aerosol Generator (FBAG) is our general-purpose powder disperser. It prepares any dry, free-flowing powder for dispersion in a gas. It disperses powders that range from 0.5 to 40 μm, with concentrations from 10 to 100 mg/m³. Unsurpassed constant output and concentration make the FBAG useful for inhalation toxicology studies, laser-velocimeter seeding, and filter testing.

FBAG Accessories (available separately)

3012	Aerosol Neutralizer (page 30)
3074B	Filtered Air Supply (page 31)
1502574	Replacement bronze beads



A variety of turntables provides flexibility when using the SSPD.

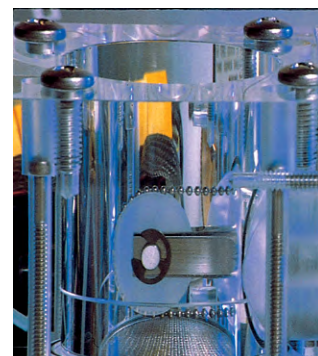

A bed of bronze beads inside the Model 3400A breaks up powder agglomerates before dispersion.

ATOMIZERS



Models 3076, 3079A, 9302 & 9306

Generate polydisperse, high-concentration aerosols.

TSI offers four highly dependable instruments for nebulizing a liquid solution or suspension:

Constant Output Atomizer Model 3076. Generates aerosols of constant particle size in concentrations over 10^7 particles/cm³ (nominal). Its nominal aerosol flow rate is 3.0 to 3.5 L/min. Stainless-steel components make this collision-type atomizer suitable for biological and medical research, material synthesis, filter testing, instrument calibration, and basic research.

Portable Atomizer Model 3079A. This rugged, compact atomizer generates particles in concentrations over 10^9 particles/cm³ and offers an adjustable flow rate from 1.0 to 4.2 L/min. A built-in, low-noise compressor provides compressed air, and the atomizer head is made entirely of stainless steel. Operating components are protected by a hood, making this atomizer highly portable and suitable for acceptance tests.

Single-Jet Atomizer Model 9302. Our simplest atomizer includes a built-in pressure regulator for controlling air from an external source. It produces particles in concentrations over 10^7 particles/cm³ at a nominal flow rate of 6.5 L/min.

Six-Jet Atomizer Model 9306. Features the highest flow rate of any TSI atomizer and a built-in dilution system. Users may select up to six jets, each producing particle concentrations greater than 10^7 particles/cm³ at 6.5 L/min (nominal at 25 psig pressure). Built-in dilution air controlled by a valve and rotameter allows you to vary the output particle concentration.

All four atomizers produce a mean droplet diameter of 0.3 μ m with a geometric standard deviation of less than 2.0. They are suitable for work with a wide range of solutions and suspensions, including polystyrene latex (PSL) spheres, dioctyl phthalate (DOP), silicon oil, salt or sugar solutions, and methylene blue.

Please specify voltage requirements when ordering Model 3079. Model 3079 is produced in Germany by Topas GmbH.

LARGE-PARTICLE AEROSOL GENERATOR



Model 8108

Generates high-concentration aerosols up to 10 μ m in diameter.

The Large-Particle Aerosol Generator produces highly concentrated aerosol over a wide particle-size range, from 0.1 to 10 μ m. Designed for easy cleaning, this generator produces potassium chloride (KCl) and other aerosols. Model 8108 meets the requirements of ASHRAE 52.2 and can also be used for ISO/TS 11155-1:2001 filter efficiency testing. It's an ideal aerosol generator for fractional efficiency testing of general ventilation filters and automotive cabin-air filters.

OIL DROPLET GENERATOR



Model 9307-6

Generates large quantities of oil droplets for seeding.

TSI's Model 9307 is a general purpose atomizer that uses a Laskin nozzle to produce large quantities of oil or salt particles. An internal impactor plate helps to generate particles with a reasonably narrow size distribution, while a valve and pressure gauge arrangement provides an easy way to control inlet air pressure, allowing for larger particle output volume if necessary.

SUBMICROMETER MONODISPERSE AEROSOL GENERATION SYSTEM



Model 3940A

A complete system for generating monodisperse, submicrometer particles.

The Submicrometer Monodisperse Aerosol Generation System gives you the ability to produce monodisperse particles from 0.01 to 1.0 μm in diameter. The system includes:

- + 3082 Electrostatic Classifier Platform (page 24)
- + 3081A Long DMA (page 24)
- + 3077A Aerosol Neutralizer (page 30)
- + 3012 Aerosol Neutralizer (page 30)
- + 3074B Filtered Air Supply (page 31)
- + 3076 Constant Output Atomizer (page 27)
- + 3062 Diffusion Dryer (page 29)
- + 1035900 Inlet Impactor
- + Interconnecting hardware

SUPERMICROMETER MONODISPERSE AEROSOL GENERATION SYSTEM

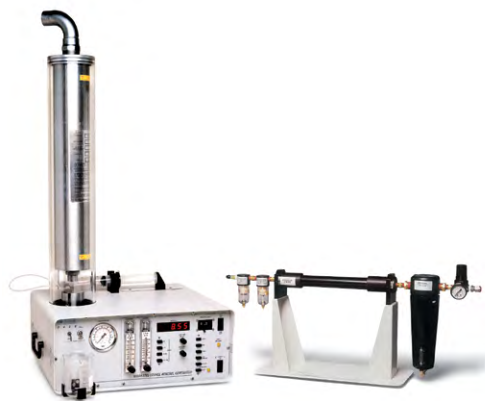

Model 3941

Everything you need to generate monodisperse particles as large as 200 micrometers.

Our Supermicrometer Monodisperse Aerosol Generation System enables you to produce the most monodisperse particles possible in a laboratory. It generates particles from 1 to 200 μm in diameter, from nearly any material that can be put into solution with a volatile solvent. System components include:

- + 3450 Vibrating Orifice Aerosol Generator (page 24)
- + 3054 Aerosol Neutralizer (page 30)
- + 3074B Filtered Air Supply (page 31)
- + 393520 10- μm orifice
- + 393530 20- μm orifice
- + 393540 35- μm orifice
- + 393550 50- μm orifice
- + 393560 100- μm orifice
- + Interconnecting hardware

INSTRUMENTS & ACCESSORIES

NANOMETER AEROSOL SAMPLER



Model 3089

Deposits 2- to 100-nm particles on TEM grids, AFM substrates, or glass slides.

The Nanometer Aerosol Sampler (NAS) allows you to sample charged particles, like those from the output of a Differential Mobility Analyzer (DMA), onto sample substrates for analysis. You control the spot size of the deposition using two electrode sizes and get a uniform deposition spot size that is optimal for your analysis system.

MASS FLOWMETER



Model 4000 Series

Monitors experimental flows, simply and reliably.

Our Mass Flowmeters are perfect for monitoring flows in your experimental setups. They measure mass flow rates up to 20 std. L/min, with exceptional accuracy at all flow rates. Plus, they measure flow volume, gas temperature, and absolute pressure. A low pressure-drop minimizes the impact of flow circuit back-pressure on your test instruments. Data appears on the LCD display in real time. Models 4140 & 4143 include an analog output for recording the flow rate and an RS-232 computer connection for operational control, data logging, and data display. An in-line HEPA filter is included to protect the flowmeter from particles in the aerosol sample and help maintain calibration. Models 4140 & 4143 are calibrated for air and have tube ends with a 0.5-inch outside diameter.

*Please specify voltage requirements.

DIFFUSION DRYER



Model 3062, 3062-NC

Removes moisture from sample aerosols.

Our Diffusion Dryer includes a removable extractor for collecting large water droplets. Desiccant surrounding the aerosol flowpath removes excess moisture by diffusional capture. Because aerosol never comes in contact with the desiccant, there is minimal particle loss. Regenerate the desiccant simply by removing it from the Diffusion Dryer and baking it at 120°C. Maximum flow rate is 4 L/min. The -NC version has identical specifications, but no cobalt.

*Please specify voltage requirements.

AEROSOL NEUTRALIZERS



Models 3012, 3054, 3077, 348002

Minimize particle losses and coagulation by electrostatic charges, or charge particles properly for size analysis or air-filter measurements.

Aerosol particles dispersed by nebulization, combustion, or powder dispersion are usually electrostatically charged and are subject to high losses during transport. To reduce transport losses and ensure that instruments operating on the electrostatic principle work properly, particles must be neutralized. TSI Aerosol Neutralizers use a radioactive source (⁸⁵Kr or ²¹⁰Po) to perform this function. The radioactive source ionizes the surrounding atmosphere creating positive and negative ions. Particles carrying a high charge can discharge by interacting with ions of opposite polarity. After a short time, the particles reach charge equilibrium. TSI recommends models 3012A, 3054A, or 3077A for aerosols with higher charge levels or when operating at higher flow rates or high concentrations.

Aerosol Neutralizers

3012	For general-purpose applications with high flow rates (up to 50 L/min)
3012A	Same as above, but with five times the activity
3054	For use with Model 3450 Vibrating Orifice Aerosol Generator (page 24)
3054A	Same as above, but with twice the activity
3077	For general-purpose applications with low flow rates (up to 5 L/min); standard with Series 3936 Scanning Mobility Particle Sizer™ spectrometers (page 1)
3077A	Same as above, but with five times the activity; included with Model 3034 Scanning Mobility Particle Sizer spectrometer
348002	Included with Model 3480 Electrospray Aerosol Generator (page 25)

*Provide end-user name and address when ordering Aerosol Neutralizers. TSI has been issued license number 1154-200-62 by the Minnesota Department of Health to sell and distribute these Aerosol Neutralizers. Users in the United States need not apply for additional U.S. Government licenses to handle these products. However, some state and local governments may require special licenses, and some organizations may have special handling procedures. Check all local requirements.

ADVANCED AEROSOL NEUTRALIZER



Model 3088

A nonradioactive aerosol neutralizer.

TSI's Advanced Aerosol Neutralizer 3088 offers an alternative to the traditional radioactive neutralizers frequently required for aerosol measurement applications. Due to increasingly stringent local, state, and national regulations, obtaining licensing to acquire and use radioactive sources is often difficult and in some cases prohibited. Fully compliant with US FDA, CDRH* standards, the Model 3088 (U.S. Patent 7,796,727) provides an attractive alternative, with sizing performance virtually identical to TSI's Aerosol Neutralizer Model 3077A.

*US FDA, CDRH - United States Food and Drug Administration, Center for Devices and Radiological Health

FILTERED AIR SUPPLY



Model 3074B

Cleans, dries, and regulates compressed air for aerosol generation and other applications.

The Filtered Air Supply removes oil or other liquid droplets from the incoming air using two prefilters. It also removes any remaining moisture in the air stream by passing the air through an advanced membrane dryer (no more drying of dessicant material!). Plus, it removes fine particles using a high-efficiency filter at the outlet. This full-featured compressed-air conditioner allows you to make pressure adjustments using an included gas-regulator valve. It handles a maximum flow rate of 60 L/min at a dewpoint as low as 2°C. Maximum inlet pressure is 1,000 kPa (150 psig).

FLOW SPLITTER



Model 3708

Routes sample from one source to several instruments.

The Flow Splitter directs an aerosol sample to as many as four destinations at once. Need only two or three flow paths? Then simply block the unused outlet ports. This accessory is especially useful when performing instrument comparison or calibration experiments. Smooth flow transitions provide equal flow distribution. Stainless-steel construction and an electropolished interior prevent the aerosol from being contaminated. The Flow Splitter has a $\frac{3}{8}$ -inch straight-tube inlet and four $\frac{1}{4}$ -inch outlets (outside diameters). Maximum total flow rate is 30 L/min.

PARTICLE SIZE SELECTOR



Model 376060

Allows selection of different cutoff sizes for CPCs.

The Particle Size Selector (PSS) allows you to control the lower size cutoff of a TSI Condensation Particle Counter (CPC). The PSS is a separating device that selectively removes small particles from an aerosol by diffusion. Simply add or remove diffusion screens to change the lower cutoff size. The cutoff shifts toward larger sizes as more screens are added.

The PSS includes 11 screens and, therefore, can be configured for 11 cutoff sizes. An extra set of 12 screens may be ordered to expand the cutoff range further. Specific cutoff sizes vary based on CPC operating flow rate.

PSS Accessory (available separately)

376061 Set of 12 additional diffusion screens

The technique of using a Condensation Particle Counter with diffusion screens to select specific particle size ranges is covered in United States Patent Number 5,072,626.

VACUUM PUMPS



Models 3032/3033

Use these top-quality pumps when you need a portable vacuum source.

Model 3032 is a diaphragm-type pump that produces flow rates up to 5 L/min. Oversized, permanently lubricated bearings promote longer life and maintenance-free operation. The pump operates in any position. We offer this small, reliable pump for use with our Model 3790, 3783, and 3772 Condensation Particle Counters, or Series 3936 Scanning Mobility Particle Sizer™ spectrometers containing a 3772 CPC.

Model 3033 produces flows up to 60 L/min. This high-quality, rotary-vane pump contains self-sealing, compound-carbon vanes that self-adjust as they wear. Therefore, it always operates at top efficiency. Permanently lubricated ball bearings make the 3033 virtually maintenance-free.

This is the pump we recommend for use with our Model 3068B Aerosol Electrometer or when using multiple CPCs that require an external vacuum source. This pump is also suitable for TSI Model 3306 Impactor Inlet when used with our supermicrometer particle sizers.

Vacuum Pumps

3032 Flow rates up to 5 L/min, 115 V

3032-1 Flow rates up to 5 L/min, 230 V

3032-EC Flow rates up to 5 L/min, 230 V (Europe only)

3033 Flow rates up to 60 L/min, 115 V (North America only, customers in other parts of the world must contact the factory for model number and power ratings.)

TSI recommends these pumps only for use with specific TSI particle instruments. Please specify voltage requirements.

PROCESS AEROSOL MONITOR



Model 3375

Monitors high-concentration, monodisperse aerosols.

The Process Aerosol Monitor (PAM) measures high-concentration, monodisperse aerosols like those produced by our Model 3475 Condensation Monodisperse Aerosol Generator (CMAG) or other Sinclair-LaMer-type generators. It monitors aerosols on-line, measuring particle size and concentration in real time.

The PAM is a compact, robust device that connects directly to the generator outlet. It validates particle size and concentration and helps confirm that the generator is working properly. It is also suitable for monitoring an aerosol while making adjustments to the generator's operating parameters.

This instrument arrives precalibrated for diethyl-hexyl sebacate (DEHS). It includes an RS-232 serial interface and a dynamic link library (DLL) routine and spreadsheet program. This enables the PAM to communicate with a computer so you can store data on a hard disk—a good idea for calibration purposes!

Please specify voltage requirements. Model 3375 are produced in Germany by Topas GmbH.

TSI Incorporated serves a global market by investigating, identifying, and solving measurement problems. As an industry leader in the design and production of precision instruments, TSI partners with research institutions and customers around the world to set the standard for measurements relating to aerosol science, air flow, health

and safety, indoor air quality, fluid dynamics, and biohazard detection. With headquarters based in the U.S. and field offices throughout Europe and Asia, TSI has established a worldwide presence in the markets we serve. Every day, our dedicated employees turn research into reality.

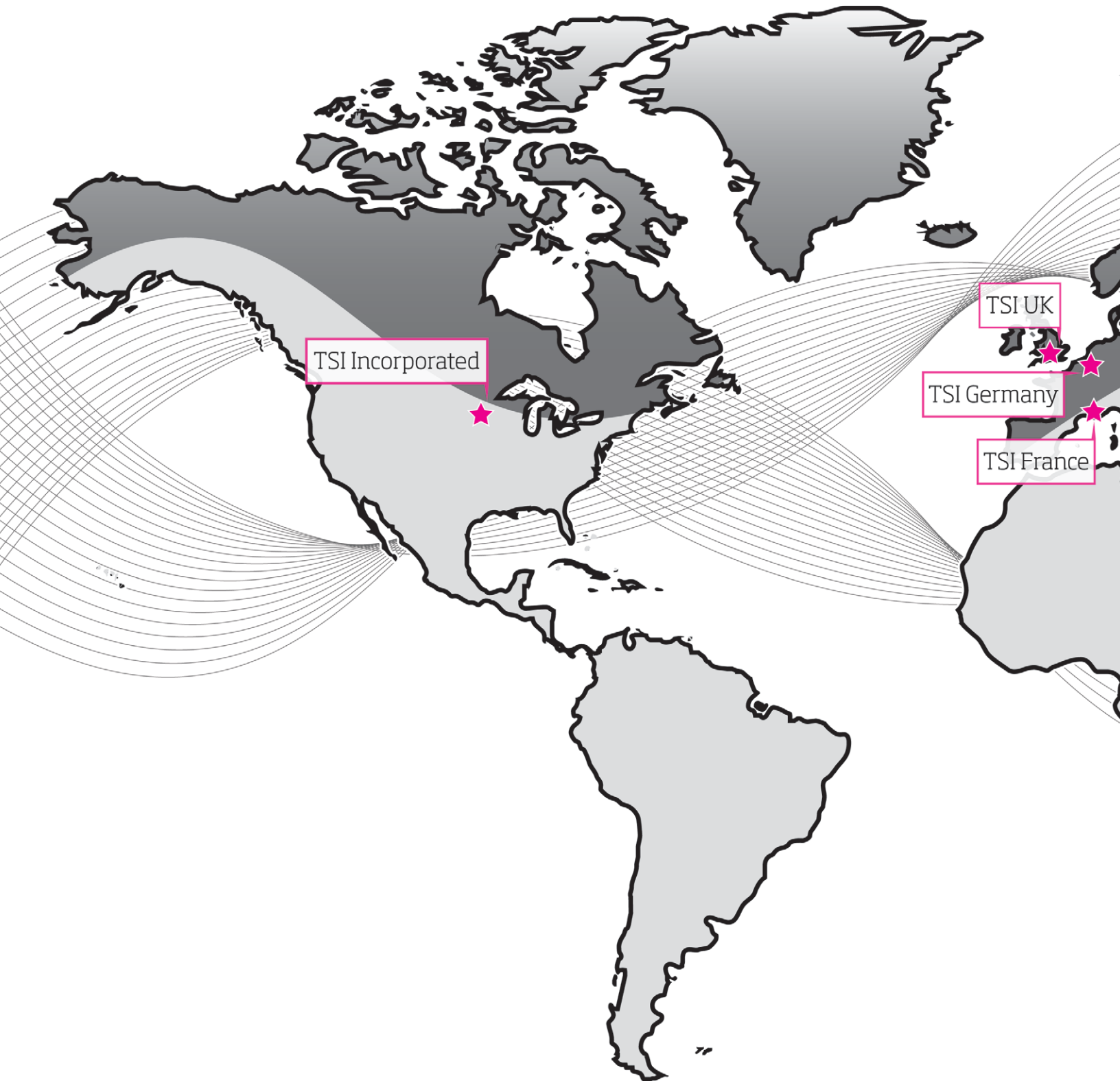

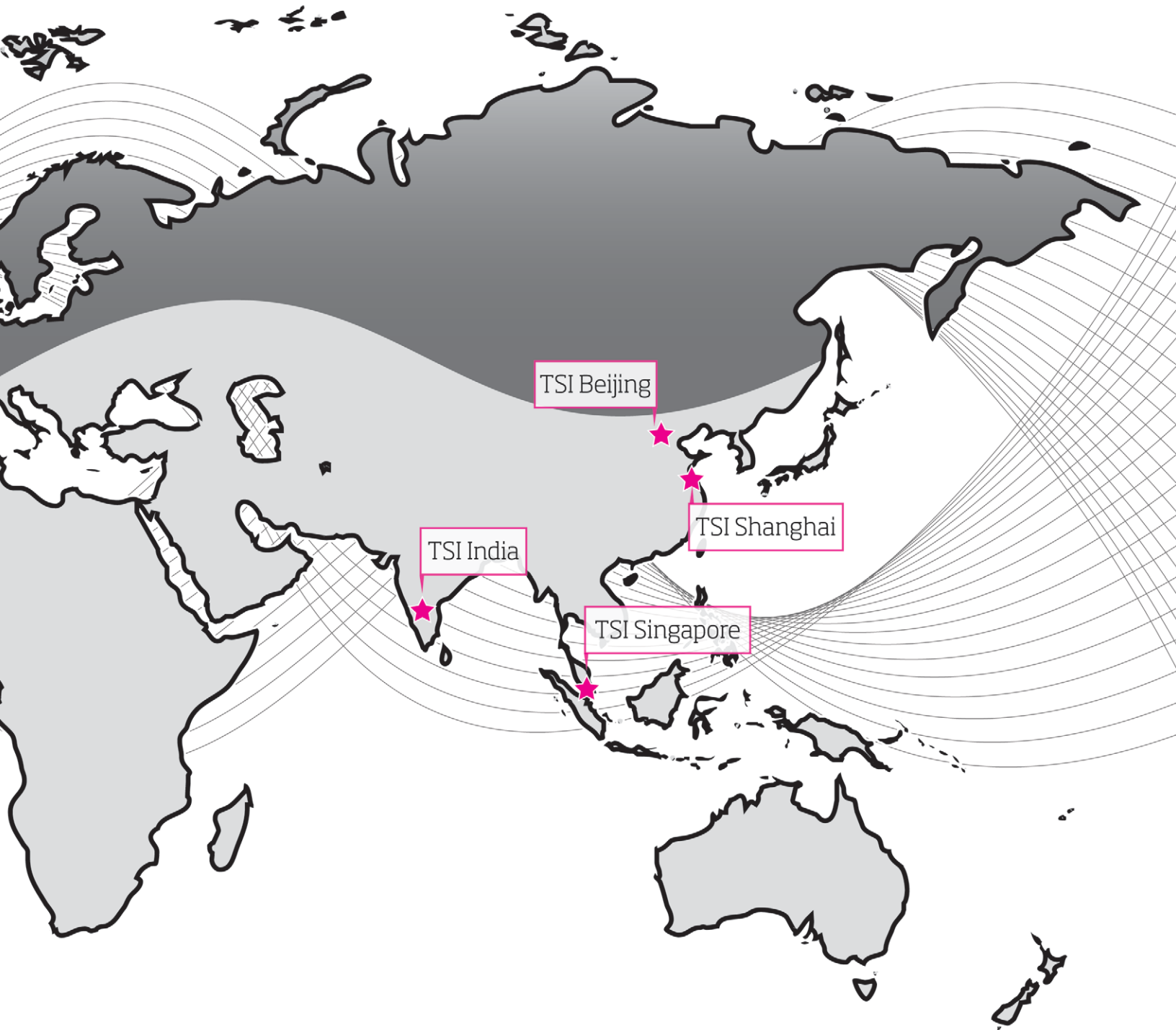

Ordering

To order, contact your nearest representative or sales office. If you don't know which office handles your territory, then contact our corporate headquarters. Our staff will answer any questions you may have or they will put you in contact with the appropriate sales office. Contact information can also be found on the TSI website. When ordering, specify the model number, instrument name, accessory models and names, and voltage requirements.

Customer Service

TSI Customer Service Specialists are available to answer your questions about installation or operation:

US & Canada: 1-800-874-2811

Europe: +49 241 523030

or www.tsi.com

General Information

TSI Incorporated manufactures innovative instruments for use in industry and research. The particle instruments described in this catalog represent only one of our product families. TSI offers a broad array of sensors and instrumentation systems used in a variety of measurement applications around the globe.

Headquartered in Shoreview, Minnesota, TSI has sales and representative offices all over the world. For more information on TSI particle instruments, use the contact information shown below or visit particle.tsi.com. For information on TSI instruments not discussed in this catalog, go to the main TSI web page at www.tsi.com

A sincere effort was made to ensure that all information in this catalog was current at the time of publication. However, specifications, features, and availability are subject to change. Please check with your TSI representative for the latest information. Prototype or early instruments are depicted in some photographs. Final products may vary from those pictured.

TSI, the TSI logo, Aerodynamic Particle Sizer, APS, Aerosol Instrument Manager, Engine Exhaust Particle Sizer, EEPS, Fast Mobility Particle Sizer, FMPS, Scanning Mobility Particle Sizer, SMPS, DustTrak and SidePak, are trademarks of TSI Incorporated.

Microsoft and Windows are trademarks of Microsoft Corporation.

LabVIEW is a trademark of National Instruments Corporation.

Aerodynamic Particle Sizer, Aerosol Instrument Manager, are registered trademarks, and APS, EEPS, Engine Exhaust Particle Sizer are trademarks



UNDERSTANDING, ACCELERATED

TSI Incorporated - Visit our website www.tsi.com for more information.

USA	Tel: +1 800 874 2811	India	Tel: +91 80 67877200
UK	Tel: +44 149 4 459200	China	Tel: +86 10 8219 7688
France	Tel: +33 1 41 19 21 99	Singapore	Tel: +65 6595 6388
Germany	Tel: +49 241 523030		